

**THE BEAUTY
OF WATER**
TEUCO CATALOGUE 2010

EN 67100608800

TEUCO CATALOGUE 2010



Teuco Guzzini S.p.A.
Via Virgilio Guzzini, 2
62010 Montelupone (MC) - Italy
T. 0039-0733-2201
F. 0039-0733-220391
www.teuco.it
teuco@teuco.it
Numero Verde 800-270270

United Kingdom: Teuco UK Ltd
160 City Road
London
EC1V 2NP
T. 0044-(0)-207-6083090
F. 0044-(0)-207-6083089
www.teuco.com
info@teuco.co.uk

France: Teuco France sarl
151 Avenue du Maine
75014 Paris
T. 033-1-58142070
F. 033-1-45452260
www.teuco.fr
info@teuco.fr

España: Teuco España s.l.
C/ Granada, 45
08740 Sant Andreu de la Barca
Barcelona
T. 0034-902-8898.03
F. 0034-902-8898.04
www.teuco.es
info@teuco.es

Russia: 000 Teuco
Via Bolshaja Cherkizovskaja, 24a
107553 Moscow
T. 007-495-5140704
F. 007-495-5648274
www.teuco.ru
info@teucorussia.ru

teuco

teuco

teuco







art direction
acanto comunicazione

art design and layout
copywriting
acanto comunicazione

photography
amati bacciardi
33 multimedia studio

selections
selecolor firenze

printing and packaging
bieffe

THE BEAUTY OF WATER	2	
BATHTUBS	4	
SHOWER ENCLOSURES	64	
SHOWER ENCLOSURE SYSTEMS	92	
COMBI UNITS	106	
EQUIPPED SHOWER PANELS	132	
WATER FEATURES AND TAPS	140	
COLOURS AND MATERIALS	152	

MISSION

Water, a vital element for our well-being.

Water is a vital element in our lives. As well as for our well-being. Through its collections, Teuco uses water to create a whole new space, a tactile and visual delight to dive into every day. A tingle from the first glance to the final touch.

Teuco. The first beauty treatment for both you and your bathroom.



1972

Teuco is the first to use **methacrylate** and revolutionises the world of bathroom design.

1974

The New York **MoMa** exhibits our Doccia Tonda (round shower) made of coloured methacrylate. It symbolises Italian style applied to innovative design and technology.



1980

Electronics start to be used in showers and baths, enhancing functionality and comfort. The **first Turkish bath** in an enclosure.



1994

Teuco launches the first dedicated **Duralight™** production plant. Since then, we have had exclusive rights to produce this material.

1995

The Hydrosonic patent: the first bathtubs to combine whirlpool with the benefits of high frequency sound waves. Even today it is still a Teuco **world exclusive**.

1998

Another innovation from Teuco: the **injection moulding** of shower enclosures, offering numerous advantages in terms of production and, above all, ease of use.

HISTORY

Virgilio Guzzini established Teuco in 1972.

Innovation, design, ergonomics and the pursuit of the best materials were the founding principles. Always ahead of its competitors in terms of techniques and styles, Teuco has been awarded a large number of prestigious acknowledgements, including the exhibition of its Doccia Tonda (round shower) at the New York MoMa and the ADI design award.

Bearing witness to its ongoing technological research, the two patents for Hydrosonic and Hydrosilence turn the whirlpool into a new and totally unique sensory experience.

This is the spirit which ranks Teuco among the greatest names in the world's wellness industry.



ADI Compasso d'Oro design award (1991) together with the other companies in the Group.

2001

Teuco launches **Evolution**, the first all-glass shower.

2005

Teuco presents **Seaside**. A new dimension of wellness for the living space.

2006

The Hydrosilence patent: the first and only truly silent whirlpool.

2007

Teuco opens its first **showroom in Paris**. Teuco Guzzini grows with the acquisition of **Spaform**, the specialist UK producer of mini-pools.

2008

FuoriSalone at the Milan furniture show: Teuco presents two radical new interpretations of Duralight™ designed by two major names from the international design scene: J.M. Wilmotte with the "Geografia" concept and Ron Arad with "Rotator", a highly innovative shower and bath system.

2009

Rotator by Ron Arad is exhibited at the **MAK Museum** in Vienna.



BATHTUBS

SIT-ON



SEASIDE T08
190x150 cm
PAGE 12



SEASIDE T07
215x200 cm
PAGE 16



SORGENTE
S01-S02: 240x158 cm
PAGE 18



NAOS
H554-554: Ø170 cm
PAGE 20



205
195x123 cm
PAGE 22



232
181x111 cm
PAGE 24



260
190x160 cm
PAGE 26



RONDÒ
H262: 181x111 cm
PAGE 28

FREE-STANDING



SEASIDE T08
190x150 cm
PAGE 12



NOOVALIS
HF01-F01: 190x90 cm
PAGE 30



YSOLA
H552-552: 185x100 cm
PAGE 32

CORNER



256
125x125 cm
PAGE 34



CORALYA
H545-545: 140x140 cm
PAGE 36



242
140x140 cm
PAGE 38



YSOLA
H550-550/H551-551
143x143 cm
PAGE 40



AVENESS
HF04-F04: 150x150 cm
PAGE 42



266
156x156 cm
PAGE 44



OUVERTURE
H287: 160x160 cm
PAGE 46

RECTANGULAR



BATHROOM SYSTEM
J.M. WILMOTTE DESIGN
560: 160x70 cm
H561-561: 170x70 cm
H562-562: 170x75 cm
H563-563: 180x80 cm
PAGE 48



ARMONYA
H543-543: 170x70-80 cm
H544-544: 180x80-90 cm
PAGE 50



THIMEA
HT03-T03: 170x70-84,5 cm
HT06-T06: 180x77-93 cm
PAGE 52



NEARIA
HF02-F02: 190x90 cm
HF03-F03: 180x90 cm
PAGE 54



530-531-532
530: 160x70-75 cm
531: 170x70-75 cm
532: 180x80-85 cm
PAGE 56



265
180x80-98 cm
PAGE 58



283
150x87-100 cm
PAGE 60



285
160x70-85 cm
PAGE 62

TEUCO WHIRLPOOLS.

Probably the best whirlpool on the market.

A unique experience.

The whirlpool produces jets of water mixed with air which trigger an alternating compression-decompression action in your body's tissue.

This:

- improves blood circulation,
- stimulates cellular metabolism,
- helps drain away excess fluid,
- smoothes and relaxes skin,
- relaxes both body and mind.

Teuco whirlpools are effective because:

- the right number of jets are placed in the correct position,
- the direction of the air-water nozzles is adjustable,
- the jet capacity can be regulated,
- the mixture of air and water is balanced,
- whirlpool operation is silent.

How do you get the best results from a whirlpool?

- prepare your skin by exfoliating first,
- to obtain the best relaxing effect, you should use the whirlpool after sports activities, even a light work out, or before going to bed; in any case, use it between meals,
- set the correct temperature and keep it constant (the ideal temperature is between 36 and 37 degrees Celsius, i.e. your body temperature).
- set the duration (the optimal duration is 15/20 minutes).
- afterwards, lay down for about 10 minutes wrapped in a warm bathrobe and nourish your skin with a good moisturising cream.

Efficiency and comfort.

CHROMOEXPERIENCE

The addition of colour to wellness treatments provides a deeply relaxing experience by involving both body and mind. Teuco's Chromoexperience enhances the sensations of being in water, by cycling the lighting through the colours of the rainbow.

For this function, Teuco has relied on the lighting technology expertise of another company in the group: iGuzzini illuminazione.



PULSATOR

This is a whirlpool feature that gradually and rhythmically increases and decreases the pressure on the skin in order to simulate a typical manual massage.

The toning effects are evident and the pleasure during treatment is very intense.



BLOWER

Blower jets generate a stream of air bubbles that float upward, creating an effect similar to "sparkling water". The numerous Teuco blower jets, from 12 to 16 depending on the model, are placed on the bottom of the tub. The sensation of a soft and relaxing massage is available at the touch of a button, even if you do not want to switch the whirlpool on.

Hygiene and safety.

HYDRO CLEAN SYSTEM

This is Teuco's patented system which comes on automatically at the end of the whirlpool. It automatically closes all jets and the suction nozzle. The bathtub is thus hermetically sealed and can be used in other modes without the risk of other substances entering the whirlpool system.

AUTOMATIC SANITISING

After a whirlpool bath, you can activate the automatic sanitising cycle which injects a chlorine-free cleanser into the system and cleans all the system components without leaving a trace.

LEVEL SWITCH (LEVEL SENSOR)

This is an important safety device which prevents the whirlpool from starting if the water in the bathtub has not reached the minimum required level.

This avoids any incorrect use of the system.

VACUUM PRESSURE SWITCH (PRESSURE SENSOR)

This is an important safety device included in all Teuco whirlpool baths.

If the suction nozzle is blocked by objects or parts of the body, the system is immediately deactivated.

Whirlpool operation is immediately restored once the obstruction is removed.

A.W.T.

The exclusive Automatic Water Treatment is an automatic system using common table salt.

The A.W.T. does away with all your water sanitising worries: everything is automatic, from the water quality control to the addition of chlorine, obtained from salt through electrolysis. Customers therefore have no need to handle chlorine directly nor do they need to worry about checking the water. They simply have to pour table salt into the water (100 grams for every 100 litres).

The A.W.T. is available in the Sorgente bathtub and in the Mirror and Seaside hydrosipas.

A comprehensive range of configurations.

The range of Teuco bathtubs offers three types of whirlpool systems featuring different levels of efficiency and comfort.



WITHOUT WHIRLPOOL



BASIC WHIRLPOOL

6 whirlpool jets, touch controls

- Basic J
- Basic G: level switch
- Basic E: level switch, automatic sanitising, Hydro Clean System



TOP HYDROSILENCE WHIRLPOOL

8 whirlpool jets, control panel and remote control with or without heater.



HYDROSILENCE

AND HYDROSONIC WHIRLPOOL

8 whirlpool jets + 8 Hydrosonic jets, control panel and remote control

- Hydrosonic GL
- Hydrosonic GXL: heater, radio, Chromoexperience (optional blower)



TEUCO: EXCLUSIVE WELL-BEING

HYDROSILENCE.
The voice of well-being is silence.





25 dbA. In other words just a little more than rustling leaves, a whisper, a light breeze. With Hydrosilence, your whirlpool only makes one sound: the natural sound of flowing water. A difference you can truly feel.

70% LESS NOISE.

Hydrosilence eliminates all artificial noise at source: - **70% fewer noise emissions** in the bath; what's left is only the **natural and relaxing sound of flowing water**.

Total relaxation: the tub makes no noise and does not vibrate, for comfort without compromise.

Relaxation for all hours: no-one around will ever be disturbed, **in the evening or at night**.

An even more efficient whirlpool: thanks to the **"myhydro" function**, the intensity of the massage is controlled by adjusting the quantity of water in the jet and the quantity of air in proportion. The perfect balance of water and air, a more **effective massage**.

Up to 50% energy savings: thanks to the special motor with adjustable power control, if the whirlpool is not set to maximum power, you can save on energy consumption.

Hydrosilence is a pleasure for everyone: it applies to **the entire range** of Teuco products and designer mini-pools.

Hydrosilence: the quietest, the most effective and probably the best whirlpool on the market.



TEUCO: EXCLUSIVE WELL-BEING

HYDROSONIC.
Beauty is never only skin deep.





Thanks to the effect of ultrasound, Hydrosonic makes the massage penetrate beneath the skin, affecting your whole body. A deep treatment, for total well-being.

THE ONLY WHIRLPOOL IN THE WORLD WITH ULTRASOUND.

Teuco bathtubs with **Hydrosonic**: the only tubs in the world to team a whirlpool with the beneficial action of **ultrasound**, thanks to a specially **patented jet**.



Traditional whirlpool



Hydrosonic

Hydrosonic reaches far beyond traditional whirlpools: its ultrasound waves can even **stimulate individual body cells**.

Deep massage: 2/3 cm below the epidermis.

Intense massage: massages the cells **3 million** times per second.

Massaging **evenly over your body**: thanks to the exclusive ultrasound jets.

Hydrosonic is a small **spa, with its 4 massage programmes** to meet your every need, at any time: beauty, after sport, tone up and anti-stress.

Why Hydrosonic is good for you:

- improved cellular metabolism
- lymphatic drainage
(to fight the unsightly appearance of cellulite)
- recovery from muscle fatigue (lactic acid)
- reduced stress and joint pain

Hydrosonic: much more than an ordinary whirlpool, with the power to rival a full spa centre in the comfort of your own home any time you want.



SEASIDE T08
TALOCCI DESIGN





SEASIDE T08
TALOCCI DESIGN
190x150 cm



**Wood finish panelling
(natural or synthetic)**



Limed oak-wood Anthracite oak-wood Wengé

Customisable covering



(For version without whirlpool)

Accessible hatch



Grey (standard) White (on request)

Bathtub colours

Standard Special



White (A) Pearl grey (U)



Water blade and concealed taps



ACCESSIBLE HATCH WITH COMPARTMENT FOR: REMOTE CONTROL, TAPS, HAND SHOWER WITH FLEXIBLE HOSE, FLOW DIVERTER, BATHTUB WATER BLADE OUTLET, CLEANSER DISPENSER

CONTROL PANEL

OVERFLOW

WHIRLPOOL

HYDROSONIC

CHROMOEXPERIENCE



Functions

	Without whirlpool	BLOWER	J	BASIC G	E	TOP	HYDROSONIC GL	GXL
Frame								
Drain column								
Concealed taps								
Whirlpool (no. of jets)			6	6	6	8	8	8
Control panel								
Massage intensity adjustment			man.	man.	man.	dig.	dig.	dig.
Level switch								
Automatic water treatment (AWT)								
Hydro Clean System								
Hydrosilence								
Remote control								
Pulsator								
Heater								
Hydrosonic								
Radio (Acoustic Panel)								
Blower (no. of jets)		16						
Chromoexperience								

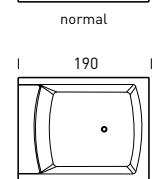
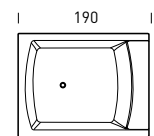
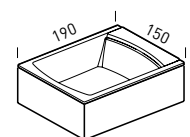

Water capacity 545 lt.
(at overflow level)

■ optional ■ standard □ not available



SEASIDE T07
TALOCCI DESIGN
215x200 cm



Wood finish furnishing solution (natural)



Limed oak-wood Anthracite oak-wood Wengé

Bathtub colours
Standard Special



White (A) Pearl grey (U)

Headrest and cushions



Grey (standard) White (on request)

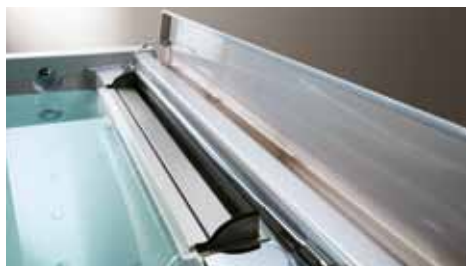

Seaside with Wengé furnishing solution

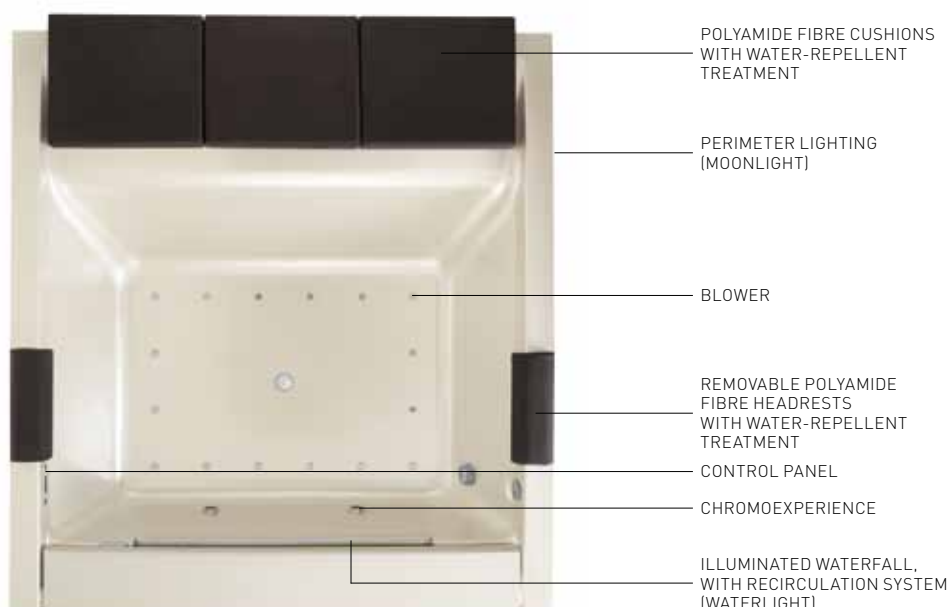

Functions

Frame	
Drain column	
Control panel	
Remote control	
Heater	
Blower (no. of jets)	16
Chromoexperience	
Perimeter lighting (moonlight)	
Illuminated waterfall (waterlight)	
Concealed taps	
Relaxation area with fabric cushions	
Fabric headrest	

Water capacity 680 lt.
(at overflow level)

standard

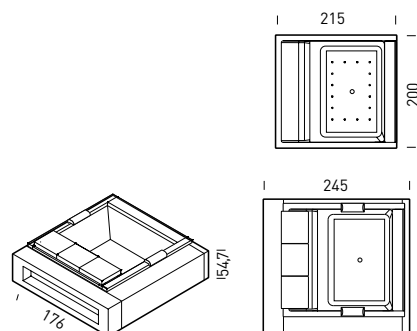

SORGENTE

LENCI DESIGN

S01-S02: 240x158 cm



Natural stone covering

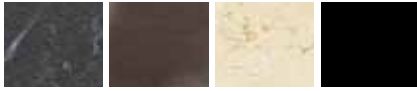

Slate grey (M1) Pierre Gris (M2) Cognac (M3) Absolut black (M4)

Wood finish laminate covering (synthetic)



Limed oak-wood Anthracite oak-wood Wengé

Customisable covering (matt black basins)



Bathtub colours

Standard Special



White (A) Pearl grey (U)

Headrest



Grey



PULL-OUT HAND SHOWER WITH FLEXIBLE HOSE

CHROMOEXPERIENCE

CONTROL PANEL



Functions

	S01	S02
Recirculation with central jet		
Hydrosilence whirlpool (no. of jets)	8	8
Chromoexperience		
Touch-screen control panel with remote control		
Level switch		
Cartridge filtration		
Drain column		
Water outlet in the tub built into the handle		
Salt-based automatic water treatment (AWT)		
Manual water chemical treatment kit		
Automatic filling		
Headrest		
Covered inspection panel on the side		
Taps		

Water capacity 530 lt. (at overflow level)

■ optional ■ standard □ not available

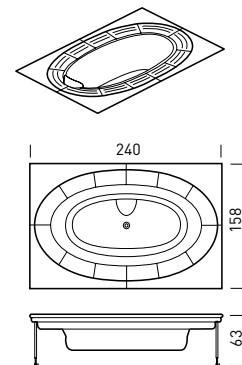

NAOS
TALOCCI DESIGN
H554-554: Ø170 cm



Wood finish accessible hatch (natural)



Limed oak-wood Anthracite oak-wood Wengé

Duralight™ accessible hatch



White (A) European White (Y)

Bathtub colours Standard



White (A) European White (Y)

Bathtub colours Specials



Pearl grey (U) Edelweiss (D)



Jasmin (E) Laser (F)

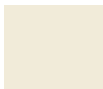

Pergamon (R)



Limed oak-wood



Anthracite oak-wood

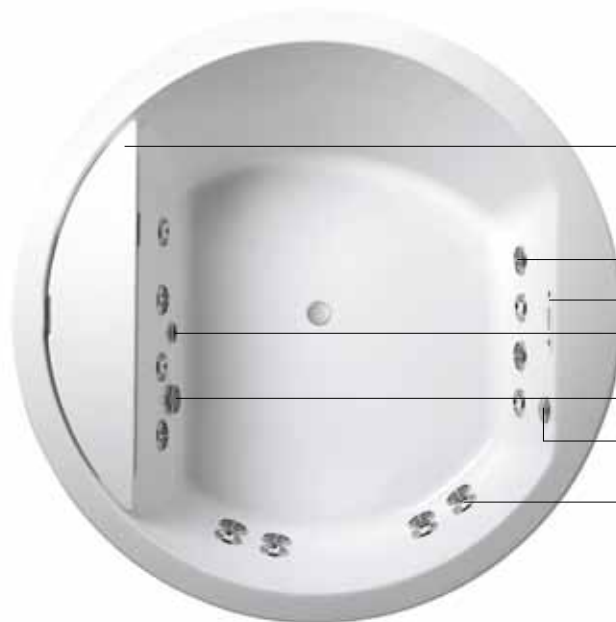

ACCESSIBLE HATCH WITH COMPARTMENT FOR: REMOTE CONTROL, TAPS, HAND SHOWER WITH FLEXIBLE HOSE, FLOW DIVERTER, BATHTUB WATER BLADE OUTLET, CLEANSER DISPENSER

HYDROSONIC

CONTROL PANEL

CHROMOEXPERIENCE

SUCTION VALVE

OVERFLOW

WHIRLPOOL

Functions

	Without whirlpool	BLOWER	J	BASIC G	E	TOP	HYDROSONIC GL	GXL
Frame								
Drain column								
Concealed taps								
Whirlpool (no. of jets)			6	6	6	8	8	8
Control panel								
Massage intensity adjustment			man.	man.	man.	dig.	dig.	dig.
Level switch								
Automatic water treatment (AWT)								
Hydro Clean System								
Hydrosilence								
Remote control								
Pulsator								
Heater								
Hydrosonic								
Radio (Acoustic Panel)								
Blower (no. of jets)		15						
Chromoexperience								

Water capacity 400 lt. (at overflow level)

■ optional ■ standard □ not available

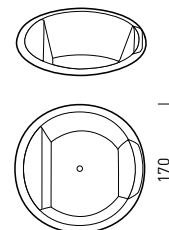

205
LENCI-TALOCCI DESIGN
195x123 cm



Bathtub colours
Standard



Bathtub colours
Specials

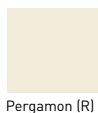
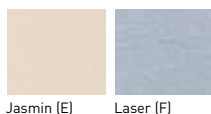

- REMOTE CONTROL
- ELBOW REST
- DRAIN HANDLE
- SLIP-RESISTANT BOTTOM
- CONTROL PANEL
- WHIRLPOOL

Functions

	Without whirlpool	TOP
Frame		
Drain column		
Whirlpool (no. of jets)		8
Control panel		
Massage intensity adjustment		dig.
Level switch		
Automatic water treatment (AWT)		
Hydro Clean System		
Remote control		
Pulsator		

Water capacity 300 lt.
(at overflow level)

optional standard not available

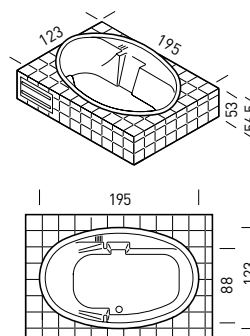

232
LENCI-TALOCCI DESIGN
181x111 cm



Bathtub colours
Standard



Bathtub colours
Specials

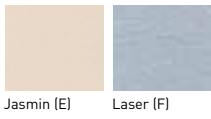

REMOTE CONTROL

STORAGE SHELF

ELBOW REST

DRAIN HANDLE

CONTROL PANEL

SLIP-RESISTANT BOTTOM

WHIRLPOOL

Functions

	Without whirlpool	TOP
Frame	Optional	Standard
Drain column	Optional	Standard
Whirlpool (no. of jets)	Not available	8
Control panel	Optional	Standard
Massage intensity adjustment	Not available	dig.
Level switch	Optional	Standard
Automatic water treatment (AWT)	Optional	Standard
Hydro Clean System	Optional	Standard
Remote control	Optional	Standard
Pulsator	Optional	Standard

Water capacity 250 lt.
(at overflow level)

optional
 standard
 not available

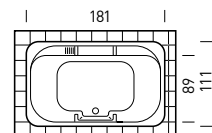
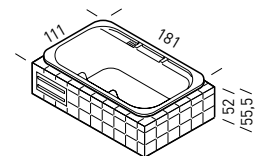

260
LENCI-TALOCCI DESIGN
190x160 cm



Bathtub colours
Standard



Bathtub colours
Specials

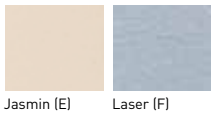

Polyurethane parts

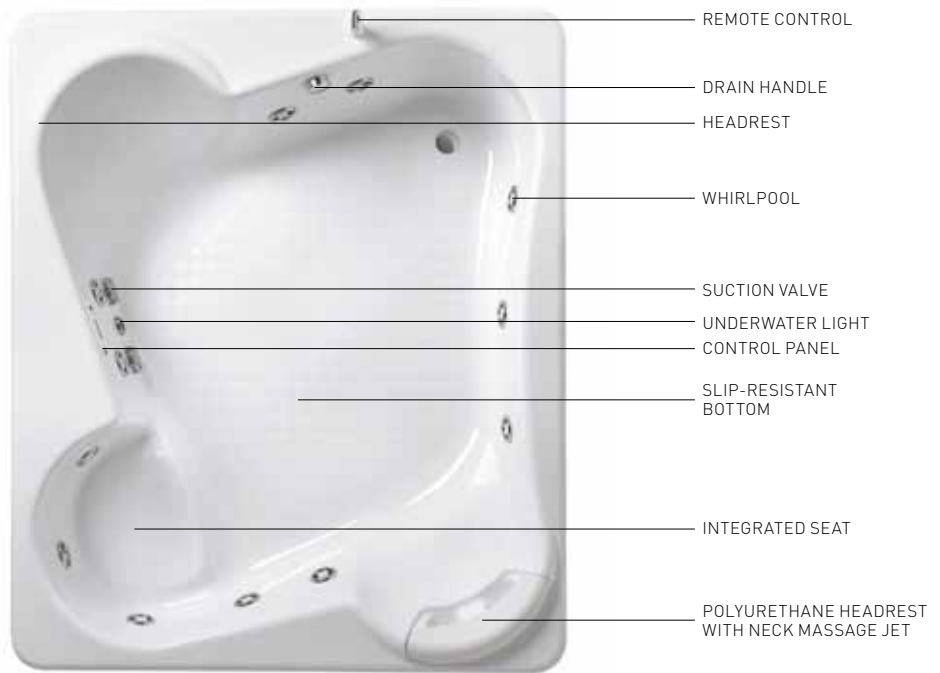
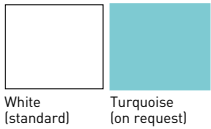

Functions

	Without whirlpool	TOP
Frame	Optional	Standard
Drain column	Optional	Standard
Whirlpool (no. of jets)	Standard	12
Control panel	Standard	Optional
Massage intensity adjustment	Standard	dig.
Level switch	Standard	Optional
Automatic water treatment (AWT)	Standard	Optional
Hydro Clean System	Standard	Optional
Remote control	Standard	Optional
Pulsator	Standard	Optional
Light	Standard	Optional
Heater	Standard	Optional
Drain column with overflow and filler spout	Optional	Standard

Water capacity 500 lt.
(at overflow level)

optional
 standard
 not available

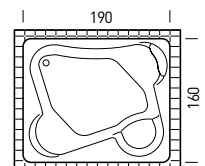
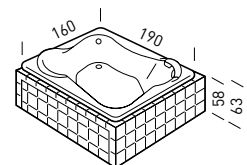

RONDÒ
LENCI-TALOCCI DESIGN
H262: 181x111 cm



Bathtub colours
Standard



Bathtub colours
Specials

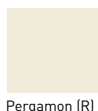

Polyurethane parts

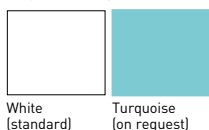

- POLYURETHANE HEADREST
- WHIRLPOOL HYDROSONIC
- HANDLE
- CONTROL PANEL
- SLIP-RESISTANT BOTTOM
- REMOTE CONTROL
- INTEGRATED SEAT
- CHROMOEXPERIENCE
- DRAIN HANDLE



Functions

	HYDROSONIC	
	GL	GXL
Frame		
Drain column		
Whirlpool (no. of jets)	8	8
Control panel		
Massage intensity adjustment	dig.	dig.
Level switch		
Automatic water treatment (AWT)		
Hydro Clean System		
Hydrosilence		
Remote control		
Pulsator		
Hydrosonic		
Radio (Acoustic Panel)		
Chromoexperience		
Heater		
Drain column with overflow and filler spout		

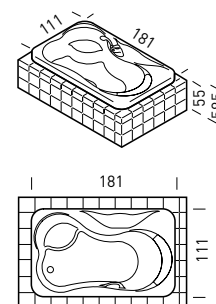

Water capacity 250 lt.
(at overflow level)

optional standard not available



NOOVALIS

FROGDESIGN

HF01-F01: 190x90 cm



Bathtub colours
Standard



Bathtub colours
Specials

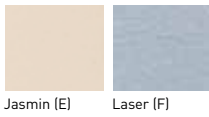

Headrest

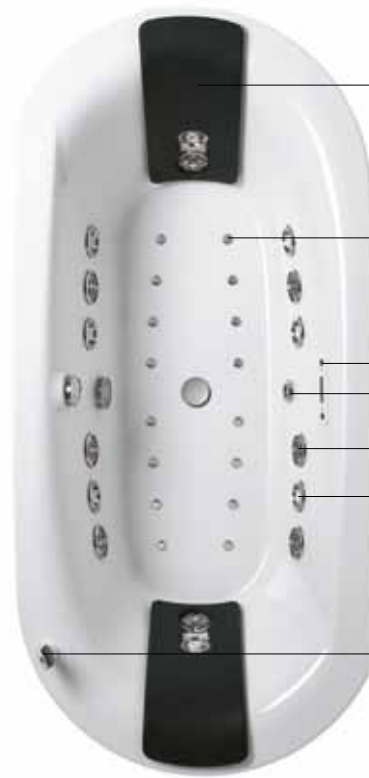

BACK PANEL AND HEADREST

BLOWER

CONTROL PANEL
CHROMOEXPERIENCE

HYDROSONIC

WHIRLPOOL

REMOTE CONTROL



Functions

	Without whirlpool	J	BASIC G	E	TOP	HYDROSONIC	
						GL	GXL
Frame							
Drain column							
Whirlpool (no. of jets)		6	6	6	8	8	8
Control panel							
Massage intensity adjustment		man.	man.	man.	dig.	dig.	dig.
Level switch							
Automatic water treatment (AWT)							
Hydro Clean System							
Hydrosilence							
Remote control							
Pulsator							
Heater							
Hydrosonic							
Radio (Acoustic Panel)							
Blower (no. of jets)							16
Chromoexperience							
Drain column with overflow and filler spout							

Water capacity 190 lt.
(at overflow level)

optional
 standard
 not available

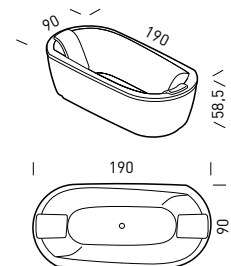

YSOLA
TALOCCI DESIGN
H552-552: 185x100 cm



Bathtub colours
Standard



Bathtub colours
Specials



Headrest



Functions

	Without whirlpool	TOP	HYDROSONIC	
			GL	GXL
Frame	Optional	Standard	Standard	Standard
Drain column	Optional	Standard	Standard	Standard
Whirlpool (no. of jets)	Not available	8	8	8
Control panel	Not available	Standard	Standard	Standard
Massage intensity adjustment	Not available	dig.	dig.	dig.
Level switch	Not available	Standard	Standard	Standard
Automatic water treatment (AWT)	Not available	Standard	Standard	Standard
Hydro Clean System	Not available	Standard	Standard	Standard
Hydrosilence	Not available	Standard	Standard	Standard
Remote control	Not available	Standard	Standard	Standard
Pulsator	Not available	Standard	Standard	Standard
Heater	Not available	Optional	Standard	Standard
Hydrosonic	Not available	Standard	Optional	Standard
Radio (Acoustic Panel)	Not available	Standard	Standard	Standard
Blower (no. of jets)	Not available	Standard	Standard	16
Chromoexperience	Optional	Standard	Standard	Standard
Drain column with overflow and filler spout	Optional	Standard	Standard	Standard

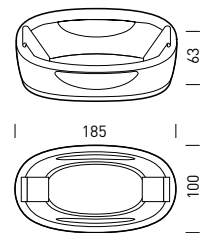

Water capacity 293 lt.
(at overflow level)

optional
 standard
 not available



256
LENCI-TALOCCI DESIGN
125x125 cm



Bathtub colours
Standard



Bathtub colours
Specials

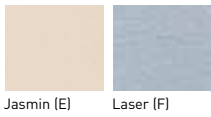

Functions

	Without whirlpool	J	BASIC G	E	TOP
Frame	Optional	Standard	Standard	Standard	Standard
Drain column	Optional	Standard	Standard	Standard	Standard
Whirlpool (no. of jets)	Standard	6	6	6	6
Control panel	Standard	man.	man.	man.	dig.
Massage intensity adjustment	Standard	Optional	Optional	Optional	Optional
Level switch	Standard	Optional	Optional	Optional	Optional
Automatic water treatment (AWT)	Standard	Optional	Optional	Optional	Optional
Hydro Clean System	Standard	Optional	Optional	Optional	Optional
Hydrosilence	Standard	Optional	Optional	Optional	Optional
Remote control	Standard	Optional	Optional	Optional	Optional
Pulsator	Standard	Optional	Optional	Optional	Optional
Chromoeperience	Optional	Optional	Optional	Optional	Optional
Drain column with overflow and filler spout	Optional	Optional	Optional	Optional	Optional

Water capacity 170 lt.
(at overflow level)

optional
 standard
 not available

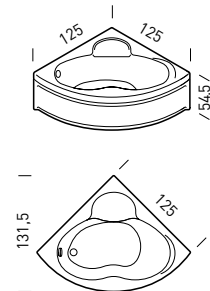

CORALYA
ANGELETTI RUZZA DESIGN

H545-545: 140x140 cm



Bathtub colours
Standard



Bathtub colours
Specials

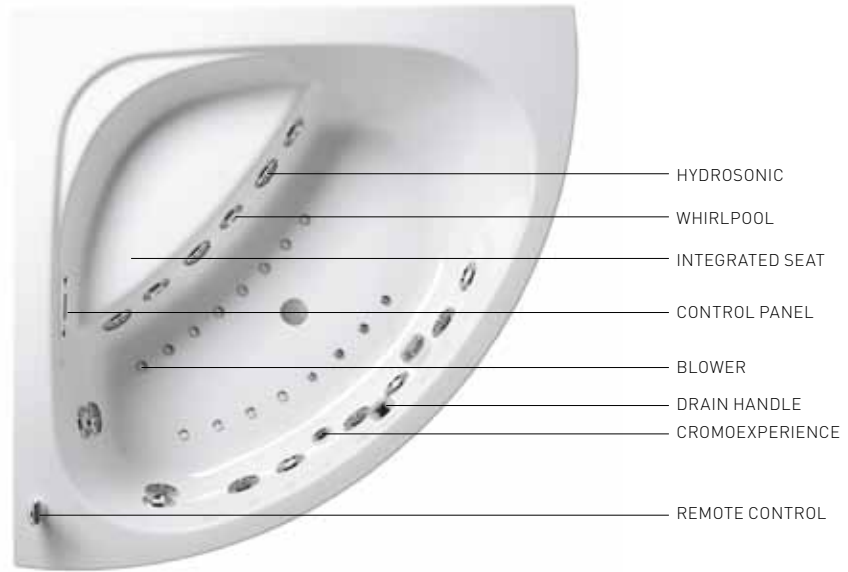
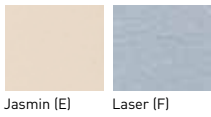

Functions

	Without whirlpool	J	BASIC G	E	TOP	HYDROSONIC	
						GL	GXL
Frame							
Drain column							
Whirlpool (no. of jets)		6	6	6	8	8	8
Control panel							
Massage intensity adjustment		man.	man.	man.	dig.	dig.	dig.
Level switch							
Automatic water treatment (AWT)							
Hydro Clean System							
Hydrosilence							
Remote control							
Pulsator							
Heater							
Hydrosonic							
Radio (Acoustic Panel)							
Blower (no. of jets)							16
Chromoexperience							
Drain column with overflow and filler spout							

Water capacity 239 lt.
(at overflow level)

■ optional ■ standard □ not available

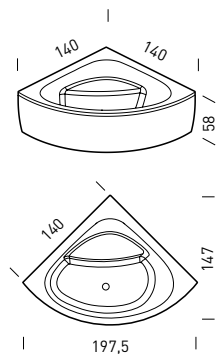

242
LENCI-TALOCCI DESIGN
140x140 cm



Bathtub colours
Standard



Bathtub colours
Specials

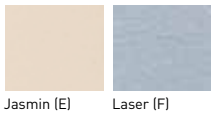

Polyurethane parts

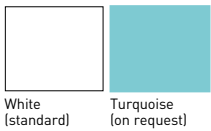

Functions

	Without whirlpool	J	BASIC G	E	TOP
Frame	Optional	Standard	Standard	Standard	Standard
Drain column	Optional	Standard	Standard	Standard	Standard
Whirlpool (no. of jets)	Standard	6	6	6	8
Control panel	Standard	Optional	Optional	Optional	Optional
Massage intensity adjustment	Standard	man.	man.	man.	dig.
Level switch	Standard	Standard	Standard	Standard	Standard
Automatic water treatment (AWT)	Standard	Standard	Standard	Standard	Standard
Hydro Clean System	Standard	Standard	Standard	Standard	Standard
Hydrosilence	Standard	Standard	Standard	Standard	Standard
Remote control	Standard	Standard	Standard	Standard	Standard
Pulsator	Standard	Standard	Standard	Standard	Standard
Drain column with overflow and filler spout	Optional	Optional	Optional	Optional	Optional

Water capacity 245 lt.
(at overflow level)

optional
 standard
 not available

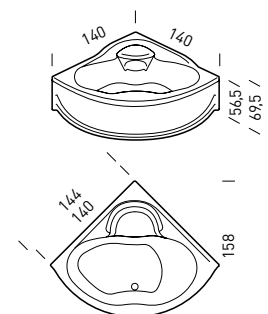

Y SOLA

TALOCCI DESIGN

H550-550: 143x143 cm

H551-551: 143x143 cm



Wooden shelf for H551-551 (natural)



Limed oak-wood Anthracite oak-wood Wengé

Customisable covering for H551-551



Limed oak-wood Anthracite oak-wood Wengé

Bathtub colours Standard



White (A) European White (Y)

Bathtub colours Specials



Edelweiss (D) Jasmin (E) Pergamon (R)

Double backrest and headrest



Grey



- CONTROL PANEL
- HYDROSONIC
- WHIRLPOOL
- CHROMOEXPERIENCE
- REMOTE CONTROL

H550 - Acrylic shelf



Functions

	Without whirlpool	TOP	HYDROSONIC	
			GL	GXL
Frame	Optional	Standard	Standard	Standard
Drain column	Optional	Standard	Standard	Standard
Whirlpool (no. of jets)	Not available	8	8	8
Control panel	Not available	Standard	Standard	Standard
Massage intensity adjustment	Not available	dig.	dig.	dig.
Level switch	Not available	Standard	Standard	Standard
Automatic water treatment (AWT)	Not available	Standard	Standard	Standard
Hydro Clean System	Not available	Standard	Standard	Standard
Hydrosilence	Not available	Standard	Standard	Standard
Remote control	Not available	Standard	Standard	Standard
Pulsator	Not available	Standard	Standard	Standard
Heater	Not available	Optional	Standard	Standard
Hydrosonic	Not available	Standard	Optional	Standard
Radio (Acoustic Panel)	Not available	Standard	Standard	Standard
Blower (no. of jets)	Not available	Standard	Standard	16
Chromoexperience	Optional	Standard	Standard	Standard
Drain column with overflow and filler spout	Optional	Standard	Standard	Standard

Water capacity 293 lt. (at overflow level)

optional
 standard
 not available

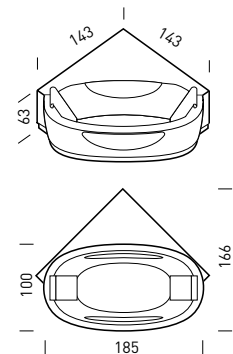

AVENESS

FROGDDESIGN

HF04-F04: 150x150 cm



Bathtub colours
Standard



Bathtub colours
Specials

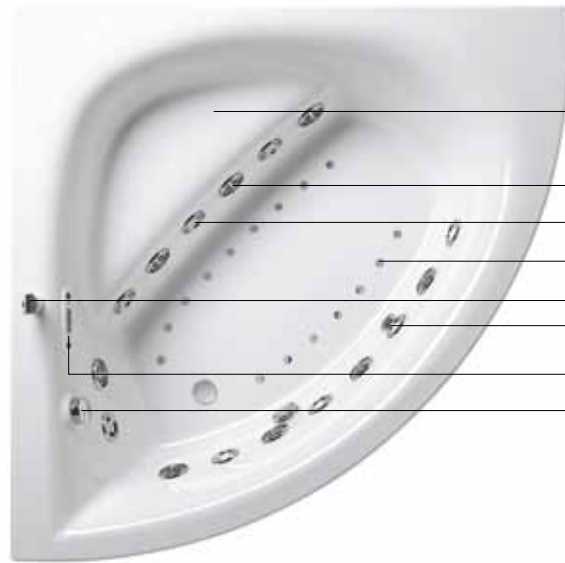
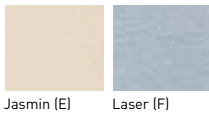

- INTEGRATED SEAT
- HYDROSONIC
- WHIRLPOOL
- BLOWER
- REMOTE CONTROL
- CHROMOEXPERIENCE
- CONTROL PANEL
- DRAIN HANDLE



Functions

	Without whirlpool	J	BASIC G	E	TOP	HYDROSONIC GL	GXL
Frame	Optional	Standard	Standard	Standard	Standard	Standard	Standard
Drain column	Optional	Standard	Standard	Standard	Standard	Standard	Standard
Whirlpool (no. of jets)	Standard	6	6	6	8	8	8
Control panel	Standard	Standard	Standard	Standard	Standard	Standard	Standard
Massage intensity adjustment	Standard	man.	man.	man.	dig.	dig.	dig.
Level switch	Standard	Standard	Standard	Standard	Standard	Standard	Standard
Automatic water treatment (AWT)	Standard	Standard	Standard	Standard	Standard	Standard	Standard
Hydro Clean System	Standard	Standard	Standard	Standard	Standard	Standard	Standard
Hydrosilence	Standard	Standard	Standard	Standard	Standard	Standard	Standard
Remote control	Standard	Standard	Standard	Standard	Standard	Standard	Standard
Pulsator	Standard	Standard	Standard	Standard	Standard	Standard	Standard
Heater	Standard	Standard	Standard	Standard	Standard	Standard	Standard
Hydrosonic	Standard	Standard	Standard	Standard	Standard	Standard	Standard
Radio (Acoustic Panel)	Standard	Standard	Standard	Standard	Standard	Standard	Standard
Blower (no. of jets)	Standard	Standard	Standard	Standard	Standard	Standard	16
Chromoexperience	Optional	Optional	Optional	Optional	Optional	Optional	Optional
Drain column with overflow and filler spout	Optional	Optional	Optional	Optional	Optional	Optional	Optional

Water capacity 240 lt.
(at overflow level)

optional
 standard
 not available

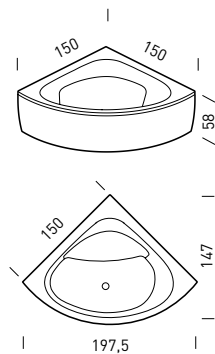

266
LENCI-TALOCCI DESIGN
156x156 cm



Bathtub colours
Standard



Bathtub colours
Specials

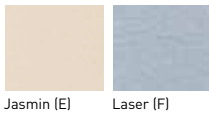

Polyurethane parts

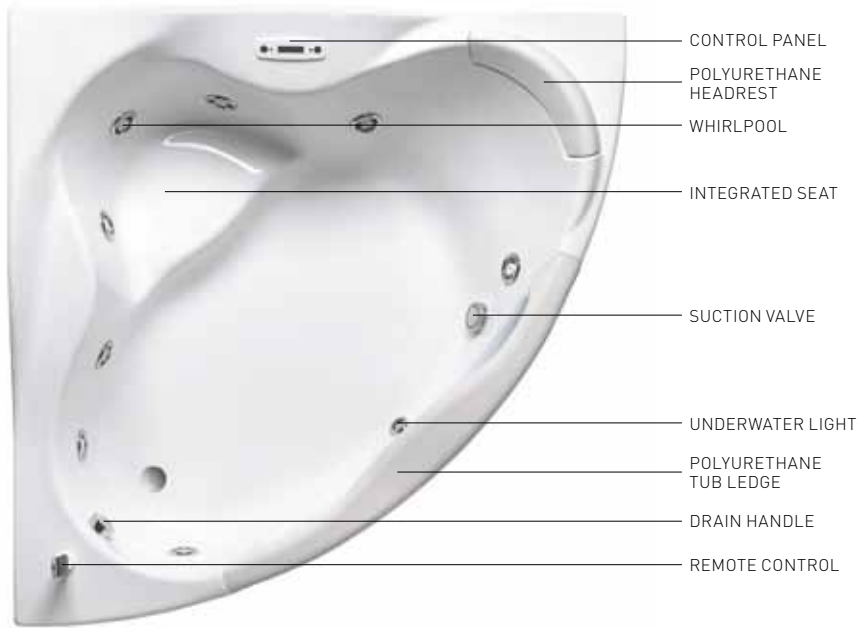
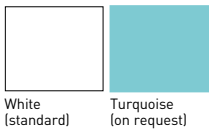

Functions

	Without whirlpool	TOP
Frame	Optional	Standard
Drain column	Optional	Standard
Whirlpool (no. of jets)	Not available	8
Control panel	Not available	Standard
Massage intensity adjustment	Not available	dig.
Level switch	Not available	Standard
Automatic water treatment (AWT)	Not available	Standard
Hydro Clean System	Not available	Standard
Hydrosilence	Not available	Standard
Remote control	Not available	Standard
Pulsator	Not available	Standard
Light	Not available	Standard
Heater	Not available	Standard
Drain column with overflow and filler spout	Optional	Standard

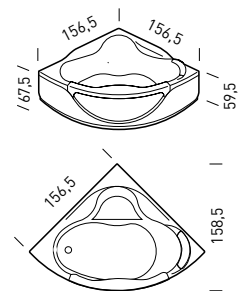

Water capacity 310 lt.
(at overflow level)

optional
 standard
 not available



OUVERTURE

LENCI-TALOCCI DESIGN

H287: 160x160 cm



Bathtub colours
Standard



Bathtub colours
Specials

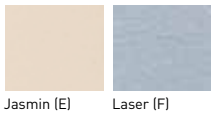

Polyurethane parts

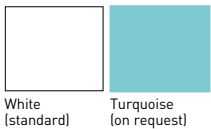

- POLYURETHANE HEADREST
- DRAIN HANDLE
- INTEGRATED SEAT
- WHIRLPOOL HYDROSONIC
- CONTROL PANEL CHROMOEXPERIENCE
- REMOTE CONTROL
- SLIP-RESISTANT BOTTOM
- POLYURETHANE TUB LEDGE
- POLYURETHANE HEADREST

Functions

	HYDROSONIC	
	GL	GXL
Frame		
Drain column		
Whirlpool (no. of jets)	8	8
Control panel		
Massage intensity adjustment	dig.	dig.
Level switch		
Automatic water treatment (AWT)		
Hydro Clean System		
Hydrosilence		
Remote control		
Pulsator		
Hydrosonic		
Radio (Acoustic Panel)		
Chromoexperience		
Heater		
Drain column with overflow and filler spout		

Water capacity 320 lt.
(at overflow level)

optional
 standard
 not available

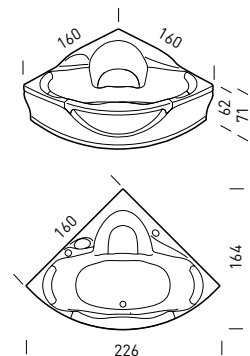

BATH COMPLETE BATHROOM SYSTEM

J.M. WILMOTTE DESIGN

560: 160x70 cm

H561-561: 170x70 cm

H562-562: 170x75 cm

H563-563: 180x80 cm



The above bathtub forms part of the Complete Bathroom System by J.M. Wilmotte.
To see all matching items, please refer to the dedicated brochure.

**Wood finish panelling
(natural or synthetic)**



Limed oak-wood Anthracite oak-wood Wengé

**Customisable covering
(for version without whirlpool)**



**Tub top
(for version without whirlpool with wooden panels)**



Duralight™ Glass

**Bathtub colours
Standard**



White (A) European White (Y)

**Bathtub colours
Specials**



Pearl grey (U) Edelweiss (D) Jasmin (E)



Laser (F) Pergamon (R)



Wood finish covered panels limed oak-wood



Wood finish covered panels
Limed oak-wood and glass top

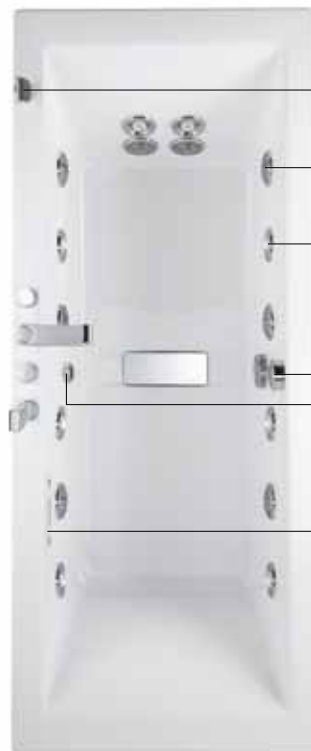

REMOTE CONTROL

HYDROSONIC

WHIRLPOOL

DRAIN HANDLE

CHROMOEXPERIENCE

CONTROL PANEL

Functions

	Without whirlpool	J	BASIC G	E	TOP	GL	GXL
Frame							
Drain column							
Whirlpool (no. of jets)		6	6	6	8	8	8
Control panel		man.	man.	man.	dig.	dig.	dig.
Massage intensity adjustment							
Level switch							
Automatic water treatment (AWT)							
Hydro Clean System							
Hydrosilence							
Remote control							
Pulsator							
Heater							
Hydrosonic							
Radio (Acoustic Panel)							
Chromoexperience							
Drain column with overflow and filler spout							

560
(not available in the Top and Hydrosonic versions)

H561-561
H562-562
H563-563

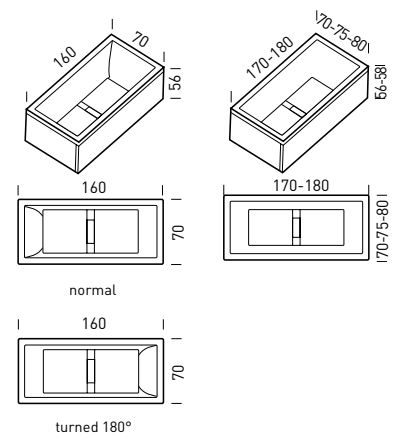

Water capacity
560 = 190 lt. - 561 = 215 lt.
562 = 215 lt. - 563 = 245 lt.
(at overflow level)

■ optional ■ standard □ not available

ARMONYA

ANGELETTI RUZZA DESIGN

H543-543: 170x70-80 cm

H544-544: 180x80-90 cm



Bathtub colours
Standard



Bathtub colours
Specials

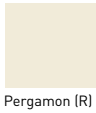
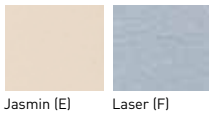

Headrest



Functions

	Without whirlpool	J	BASIC G	E	TOP	HYDROSONIC GL	GXL
Frame							
Drain column							
Whirlpool (no. of jets)		6	6	6	8	8	8
Control panel							
Massage intensity adjustment		man.	man.	man.	dig.	dig.	dig.
Level switch							
Automatic water treatment (AWT)							
Hydro Clean System							
Hydrosilence							
Remote control							
Pulsator							
Heater							
Hydrosonic							
Radio (Acoustic Panel)							
Blower (no. of jets)							16
Chromoexperience							
Drain column with overflow and filler spout							

Water capacity:
543 = 195 lt. - 544 = 235 lt.
(at overflow level)

■ optional ■ standard □ not available

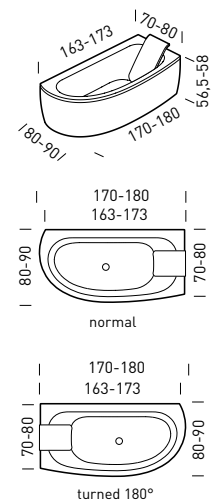

THIMEA

TALOCCI DESIGN

HT03-T03: 170x70-84,5 cm

HT06-T06: 180x77-93 cm



Bathtub colours
Standard



Bathtub colours
Specials

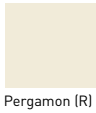
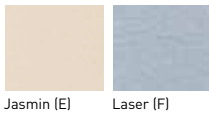

Headrest



REMOVABLE HEADREST

HYDROSONIC

WHIRLPOOL

CHROMOEXPERIENCE

BLOWER

CONTROL PANEL

REMOTE CONTROL



Functions

	Without whirlpool	J	BASIC G	E	TOP	HYDROSONIC GL	GXL
Frame							
Drain column							
Whirlpool (no. of jets)		6	6	6	8	8	8
Control panel							
Massage intensity adjustment		man.	man.	man.	dig.	dig.	dig.
Level switch							
Automatic water treatment (AWT)							
Hydro Clean System							
Hydrosilence							
Remote control							
Pulsator							
Heater							
Hydrosonic							
Radio (Acoustic Panel)							
Blower (no. of jets)							12
Chromoexperience							
Drain column with overflow and filler spout							

Water capacity:
T03 = 200 lt. - T06 = 242 lt.
(at overflow level)

■ optional □ standard □ not available

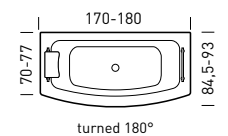
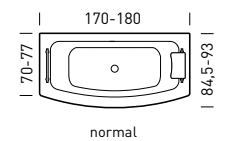
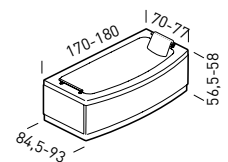

NEARIA

FROGDISEIGN

HF02-F02: 190x90 cm

HF03-F03: 180x90 cm



**Wood finish panelling
(natural or synthetic)**



Limed oak-wood Anthracite oak-wood Wengé

**Customisable covering
(for version without whirlpool)**



**Tub top
(for version without whirlpool with wooden panels)**



Duralight™ Glass

**Bath tub colours
Standard**



White (A) European White (Y)

**Bath tub colours
Specials**



Pearl grey (U) Edelweiss (D) Jasmin (E)



Laser (F) Pergamon (R)

Headrest



Grey



Wengé wood finish version with glass top

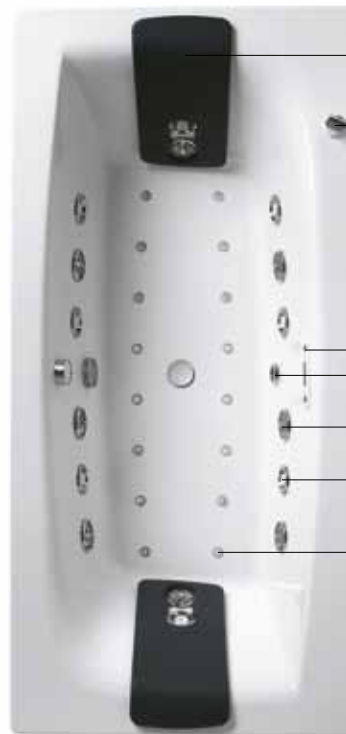

BACK PANEL
REMOTE CONTROL

CONTROL PANEL
CROMOEXPERIENCE

HYDROSONIC
WHIRLPOOL

BLOWER



Functions

	Without whirlpool	J	BASIC G	E	TOP	HYDROSONIC GL	GXL
Frame							
Drain column							
Whirlpool (no. of jets)		6	6	6	8	8	8
Control panel							
Massage intensity adjustment		man.	man.	man.	dig.	dig.	dig.
Level switch							
Automatic water treatment (AWT)							
Hydro Clean System							
Hydrosilence							
Remote control							
Pulsator							
Heater							
Hydrosonic							
Radio (Acoustic Panel)							
Blower (no. of jets)							16
Chromoexperience							
Drain column with overflow and filler spout							

Water capacity:
F03 = 210 lt. - F02 = 223 lt.
(at overflow level)

■ optional ■ standard □ not available

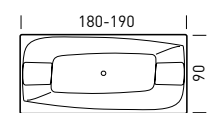
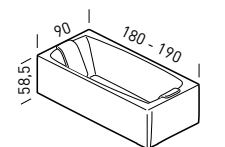

530-531-532

ANGELETTI RUZZA DESIGN

530: 160x70-75 cm

531: 170x70-75 cm

532: 180x80-85 cm



Bathtub colours
Standard



Bathtub colours
Specials

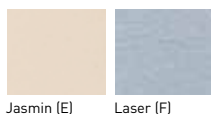

Functions

	Without whirlpool	J	BASIC G	E
Frame	optional	optional	optional	optional
Drain column	optional	optional	optional	optional
Whirlpool (no. of jets)		6	6	6
Control panel		optional	optional	optional
Massage intensity adjustment		man.	man.	man.
Level switch			optional	optional
Automatic water treatment (AWT)				optional
Hydro Clean System				optional
Chromoexperience	optional	optional	optional	optional
Drain column with overflow and filler spout	optional	optional	optional	optional

Water capacity:
530 = 173 lt. - 531 = 180 lt. - 532 = 252 lt.
(at overflow level)

optional
 standard
 not available

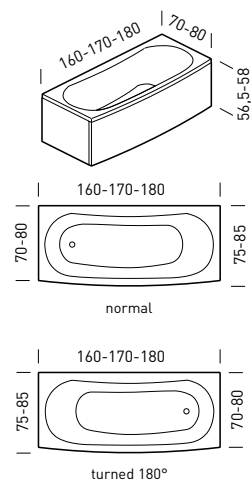

265
LENCI DESIGN
180x80-98 cm



Bathtub colours
Standard



Bathtub colours
Specials

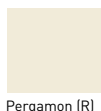

Polyurethane parts

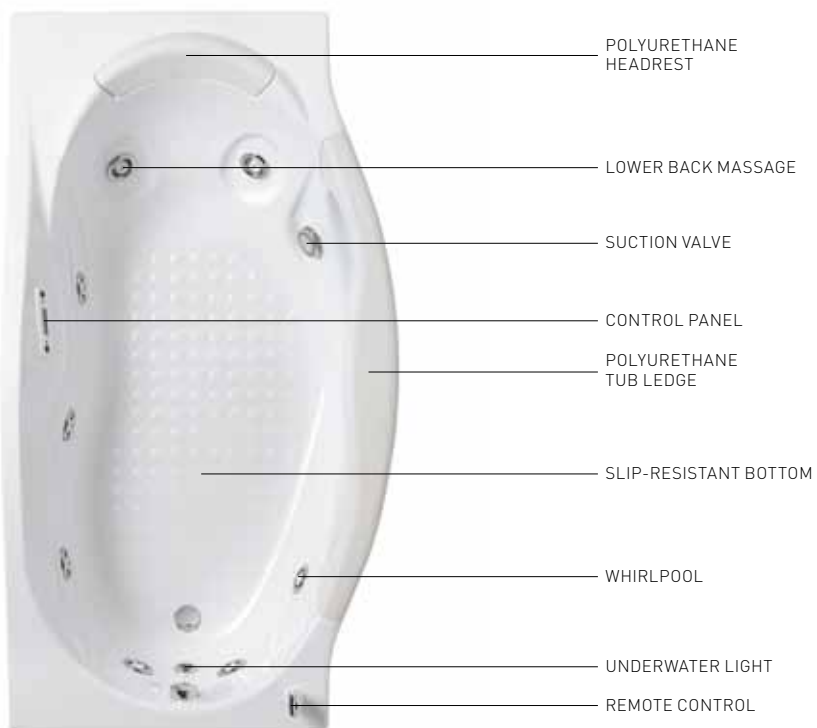
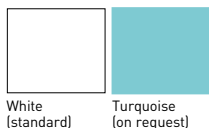

Functions

TOP

Frame	
Drain column	
Whirlpool (no. of jets)	8
Control panel	
Massage intensity adjustment	dig.
Level switch	
Automatic water treatment (AWT)	
Hydro Clean System	
Hydrosilence	
Remote control	
Pulsator	
Light	
Heater	
Drain column with overflow and filler spout	

Water capacity 285 lt.
(at overflow level)

optional standard

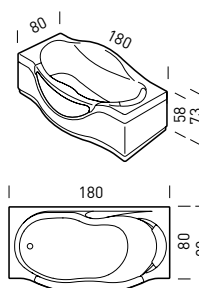

283
TALOCCI DESIGN
150x87-100 cm



Bathtub colours
Standard



Bathtub colours
Specials

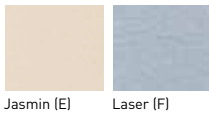

Polyurethane parts

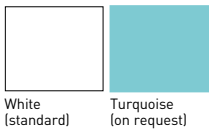

Functions

	Without whirlpool	J	BASIC G	E	TOP
Frame	Optional	Optional	Optional	Optional	Optional
Drain column	Optional	Optional	Optional	Optional	Optional
Whirlpool (no. of jets)	Optional	6	6	6	6
Control panel	Optional	Optional	Optional	Optional	Optional
Massage intensity adjustment	Optional	man.	man.	man.	dig.
Level switch	Optional	Optional	Optional	Optional	Optional
Automatic water treatment (AWT)	Optional	Optional	Optional	Optional	Optional
Hydro Clean System	Optional	Optional	Optional	Optional	Optional
Hydrosilence	Optional	Optional	Optional	Optional	Optional
Remote control	Optional	Optional	Optional	Optional	Optional
Pulsator	Optional	Optional	Optional	Optional	Optional
Chromoeperience	Optional	Optional	Optional	Optional	Optional
Drain column with overflow and filler spout	Optional	Optional	Optional	Optional	Optional

Water capacity 185 lt.
(at overflow level)

optional
 standard
 not available

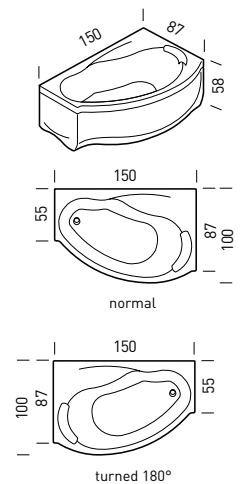

285
LENCI-TALOCCHI DESIGN
160x70-85 cm



Bathtub colours
Standard



Bathtub colours
Specials

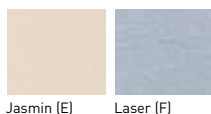

Functions

	Without whirlpool	EASY	TOP
Frame	optional	standard	standard
Drain column	optional	standard	standard
Whirlpool (no. of jets)	not available	6	6
Control panel	not available	man.	dig.
Massage intensity adjustment	not available	standard	standard
Level switch	not available	standard	standard
Automatic water treatment (AWT)	not available	standard	standard
Hydro Clean System	not available	standard	standard
Hydrosilence	not available	standard	standard
Remote control	not available	standard	standard
Pulsator	not available	standard	standard
Drain column with overflow and filler spout	optional	optional	optional

Water capacity 180 lt.
(at overflow level)

optional
 standard
 not available

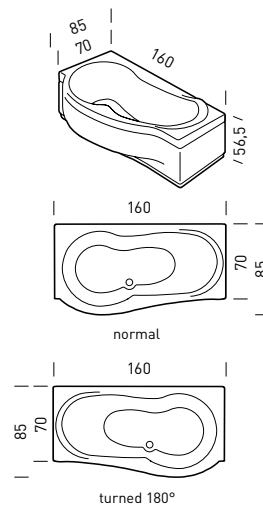

SHOWER ENCLOSURES

EVOLUTION



EVOLUTION E01
134x134 cm
PAGE 70



EVOLUTION E02
114x114 cm
PAGE 72



EVOLUTION E04
120x90 cm
PAGE 74

NEXT+



155
95x95 cm
PAGE 76



156
90x90 cm
PAGE 78



157
112x66,5-80 cm
PAGE 80

NEXT



140 NEXT
140x92 cm
PAGE 82



146 NEXT
110x80 cm
PAGE 84



148 NEXT
115x85 cm
PAGE 86



154 NEXT
90x75 cm
PAGE 88



161 NEXT
90x90 cm
PAGE 90

SHOWER ENCLOSURES.

The perfect combination of well-being and aesthetic appeal.

A unique experience.

The 100% steam Turkish bath, the energising shower and the localised massages are all uniquely enjoyable experiences available thanks to Teuco shower enclosures.

EVOLUTION

High profile enclosures capable of giving you strong emotions. The clean and geometric design is based on the use of glass: light, invisible and yet resistant.

A thickness of 8 mm makes it solid and the exclusive Clean Glass antilime-scale treatment, available on all versions, keeps the original glazing effect.

The Duralight™ shower tray is made with a material which merges high performance with a unique texture to ensure prestigious design and beguiling tactile sensations.

NEXT+

Reliable well-being guaranteed by quality construction and materials, such as the high quality **acrylic** which helps to keep the temperature inside the enclosure constant. It is durable and eco-friendly since it can be recycled.

Next+ shower enclosures have the solidity of an indestructible product and are designed to fit in with any décor and to accommodate your every need:

- **lightness and transparency;**
- **great attention to ergonomics, comfort and internal space;**
- **wide choice of shower and Turkish bath functions and versions;**
- **simple installation**
(slot-in assembly system, limited number of components, absence of silicone)

Efficiency and comfort.

LYMPHATIC DRAINAGE

This reactivates and enhances blood circulation and reduces excess fluid. It creates a general feeling of relief from swelling and heaviness. When this function is selected, the vertical massage jets are activated in sequence, from the bottom up, replicating a manual lymphatic drainage treatment.

SCOTTISH SHOWER

A proper work-out for both skin and muscles, an excellent treatment for revitalising blood circulation and making blood vessels and skin more elastic.

It is based on alternating hot and cold jets and is available with all water massages.

Hot water helps ease muscle tension, while cold water tones up tissues.

CHROMOEXPERIENCE

The addition of colour to wellness treatments provides a deeply relaxing experience by involving both body and mind.

Teamed with the steam of a Turkish bath or water massages, coloured light **regenerates mind and body**, but it can also be used when you are not in the enclosure, to create a **pleasant atmosphere** in the bathroom. For this function, Teuco has relied on the lighting technology expertise of another company in the group: iGuzzini illuminazione.

AROMATHERAPY

The Turkish bath is a traditional way to purify and tone the body and mind. Using essential oils and herbs during treatment can be very beneficial.

These essences are absorbed by breathing but also by the body which is immersed in the steam, for beautiful, relaxing sensations.

The Teuco Turkish bath is fitted with a steam outlet and dispenser which can be filled with specific aromatic oils as well as with sachets of phytocosmetic herbs.

Hygiene and safety.

TEMPERED GLASS PANELS

The glass used to make Teuco panels is hardened via a thermal treatment (tempered).

It is very resistant and considered safety glass since, in addition to being strong, it tends to shatter into small rounded pieces which are not particularly dangerous.

CLEAN GLASS

This is Teuco's exclusive lime scale removing treatment for glass panels. Thanks to CleanGlass, water slides off the surface, leaving the glass clear at all times. Cleaning the enclosure takes no time at all: after showering, simply use a dry cloth to wipe away any remaining drops on the panels. It is vital that you don't use specific glass cleaning products as their alkaline-based ingredients could cause irreparable damage to CleanGlass.

DESCALING SYSTEM

In versions fitted with a Turkish bath, this system removes lime scale deposits from the steam generator thanks to a descaling system. The life cycle of the entire system and greater energy efficiency are thus guaranteed.

A comprehensive range of configurations.

The extensive range of Teuco showers offers different types of systems featuring different levels of efficiency and comfort to meet your every need.

NEXT+ SHOWERS

(acrylic, glass)

- Basic
- Multi-function Light
- Multi-function
- Comfort Light: Turkish bath on/off
- Comfort:
 - Turkish bath with temperature selector
- Executive:
 - Turkish bath with temperature selector, lymphatic drainage, Scottish shower, radio

EVOLUTION SHOWER ENCLOSURES

(glass, Duralight™ shower tray)

- Multi-function Light
- Multi-function
- Turkish bath Light:
 - Turkish bath with temperature selector
- Turkish bath:
 - Turkish bath with temperature selector, lymphatic drainage, Scottish shower, radio, Chromoexperience



TEUCO: EXCLUSIVE WELL-BEING

THE TURKISH BATH, 100% steam.



In 1980, Teuco was the first company to bring steam into a shower enclosure thanks to electronics.

A know-how that is constantly being improved, with patents and exclusive solutions designed to observe the principles of **heat therapy** and a **proper Turkish bath**:

1) Correct temperature (40-50 °C) and 100% steam

The power rating of the system differs depending on the size and performance of each individual Teuco shower enclosure: **2,5 kW- 2,9 kW- 5 kW**

This makes it possible to always:

- reach the optimal temperature of **40-50 °C inside the enclosure**
- produce a high quantity of **steam (100%)**.

2) Even temperature throughout the entire enclosure

Warm air generally tends to rise. For this reason, Teuco developed the **recirculation system**: a fan continuously sucks the warm air back downwards, reintroducing it into the enclosure through the vaporiser.

This way, the temperature inside the enclosure is always even, from head to toe, for the entire duration of the treatment.

3) Constant temperature and energy savings

Teuco shower enclosures are fitted with a **small compact boiler (0.5 litres)** which guarantees a constant and immediate supply of steam: the enclosure is ready for use in just a few minutes and the energy consumption is kept to a minimum.

The Turkish bath: an enjoyable, relaxing and beneficial ritual.

Teuco Turkish baths not only afford moments of relaxation, but also **beneficial effects for the appearance of your skin and the health of the respiratory tract**. **Aromas and essential oils** can be added to the steam, thus stimulating your sense of smell too. You can also add **Chromoexperience**, a system of coloured lights designed in conjunction with iGuzzini illuminazione. Teamed with the steam



of the Turkish bath or the effects of water massages, coloured light **regenerates both body and mind**.

It can also be used when you are not in the enclosure, to create a **pleasant atmosphere** in the bathroom.

EVOLUTION E01

LENCI DESIGN

134x134 cm



Shower tray colours
Duralight™



UNDERNEATH THE ROOF:
CHROMOEXPERIENCE,
SHOWER HEAD AND HI-FI
LOUDSPEAKERS

SWIVEL STORAGE
SHELF

CONTROL PANEL

THERMOSTATIC
MIXER

HAND SHOWER

VERTICAL
MASSAGE JET

SWIVEL SEAT
ON RAIL

STEAM OUTLET
AND AROMATHERAPY
OIL DISPENSER

SHOWER TRAY
IN DURALIGHT™

Functions

	E01 Multi-function	E01 Multi-function with Turkish bath
Hand shower		
Roof with central shower head		
Thermostatic Mixer		
Vertical massage		
Clean glass		
Water massage selection	man.	dig.
Swivel seats		
Control panel		
Ceiling light		
Aromatherapy oil dispenser		
Scottish shower		
Radio stereo (Acoustic Panel)		
Chromoexperience		
Electronic flow diverter		
Turkish bath with temperature control		
Subwoofer		

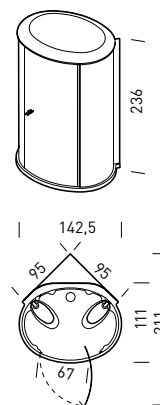

optional
 standard
 not available

EVOLUTION E02

LENCI DESIGN

E02-E02 LIGHT: 114x114 cm



Shower tray colours
Duralight™



E02 LIGHT



E02

UNDERNEATH THE ROOF:
CHROMOEXPERIENCE,
SHOWER HEAD AND HI-FI
LOUDSPEAKERS

SWIVEL
STORAGE SHELF

CONTROL PANEL

THERMOSTATIC
MIXER

HAND SHOWER

VERTICAL
MASSAGE JET

SWIVEL SEAT
ON RAIL

STEAM OUTLET
AND AROMATHERAPY
OIL DISPENSER

SHOWER TRAY
IN DURALIGHT™

Functions

	E02 Multi-function LIGHT	E02 Multi-function	E02 Multi-function LIGHT with Turkish bath	E02 Multi-function with Turkish bath
Hand shower				
Roof with central shower head				
Thermostatic Mixer				
Vertical massage				
Clean glass				
Water massage selection	man.	man.	man.	dig.
Control panel				
Ceiling light				
Aromatherapy oil dispenser				
Removable methacrylate seat	optional			
Swivel seats		optional		
Scottish shower				
Radio stereo (Acoustic Panel)				
Chromoexperience				
Electronic flow diverter				
Turkish bath with temperature control			optional	
Subwoofer				optional

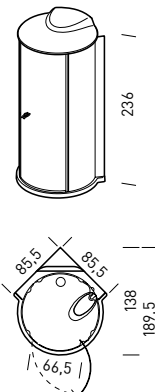

optional standard not available

EVOLUTION E04

LENCI DESIGN

E04-E04 LIGHT: 120x90 cm



Shower tray colours
Duralight™



E04 LIGHT



E04

UNDERNEATH THE ROOF:
CHROMOEXPERIENCE,
SHOWER HEAD AND HI-FI
LOUDSPEAKERS

SWIVEL STORAGE
SHELF

CONTROL PANEL

THERMOSTATIC
MIXER

HAND SHOWER

VERTICAL
MASSAGE JET

SWIVEL SEAT
ON RAIL

STEAM OUTLET
AND AROMATHERAPY
OIL DISPENSER

SHOWER TRAY
IN DURALIGHT™

Functions

	E04 Multi-function LIGHT	E04 Multi-function	E04 Multi-function LIGHT with Turkish bath	E04 Multi-function with Turkish bath
Hand shower				
Roof with central shower head				
Thermostatic Mixer				
Vertical massage				
Clean glass				
Water massage selection	man.	man.	man.	dig.
Control panel				
Ceiling light				
Aromatherapy oil dispenser				
Removable methacrylate seat	optional			
Swivel seats		optional		
Scottish shower				
Radio stereo (Acoustic Panel)				
Subwoofer				optional
Chromoexperience				optional
Electronic flow diverter				optional
Turkish bath with temperature control			optional	optional



optional
 standard
 not available

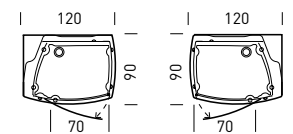
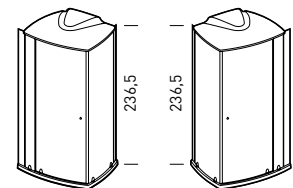

right version

left version

155
GIOACCHINI DESIGN
95x95 cm



Shower enclosure colours (Acrylic)



Combinations (Acrylic)

[7] Pearl Ice/Grey (SKY)



[Q] Pearl Ice/A

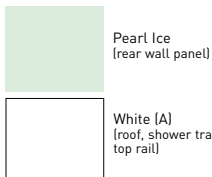

[K] Pearl Ice/Y

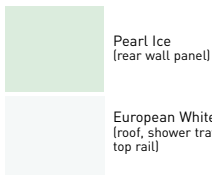

[Z] Pearl White/Y

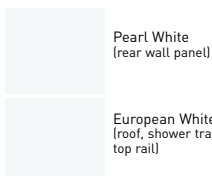

- DUAL FUNCTION CENTRAL SHOWER HEAD WITH LIGHT
- HAND SHOWER ON RAIL
- AIR RECIRCULATION
- TAPS
- CONTROL PANEL
- MULTI-FUNCTION JET
- FOLD-DOWN SEAT
- MASSAGING STRIP
- STEAM OUTLET AND AROMATHERAPY OIL DISPENSER

Functions

	155 Base	155 Multi-function LIGHT	155 Multi-function	155 COMFORT LIGHT	155 COMFORT	155 EXECUTIVE
Hand shower						
Central shower head						
Roof						
Thermostatic mixer or single lever mixer tap						
Clean glass						
Water massage selection		man.	man.	man.	man.	dig.
Vertical massage						
Water test nozzle						
Massaging strip						
Fold-down seat						
Removable methacrylate seat						
Control panel						
Aromatherapy oil dispenser						
Air recirculation						
Descaling						
Turkish bath with temperature control						
Turkish bath						
Ceiling light						
Scottish shower						
Radio (Acoustic Panel)						
Lymphatic drainage						



optional
 standard
 not available

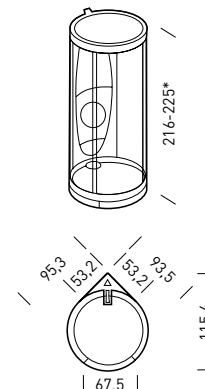

* = the shower tray can be 85 mm or 175 mm deep

156
GIOACCHINI DESIGN
90x90 cm



Shower enclosure colours (Acrylic)



Combinations (Acrylic)

[7] Pearl Ice/Grey (SKY)



[Q] Pearl Ice/A

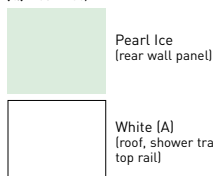

[K] Pearl Ice/Y

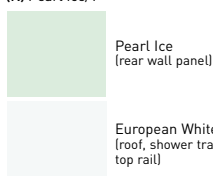

[Z] Pearl White/Y

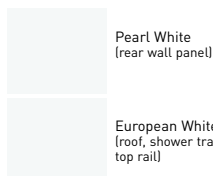

Version with transparent side panels



Functions

	156 Base	156 Multi-function LIGHT	156 Multi-function	156 COMFORT LIGHT	156 COMFORT
Hand shower					
Central shower head					
Roof					
Thermostatic mixer or single lever mixer tap					
Clean glass					
Water massage selection		man.	man.	man.	man.
Vertical massage					
Water test nozzle					
Massaging strip					
Fold-down seat					
Removable methacrylate seat					
Control panel					
Aromatherapy oil dispenser					
Air recirculation					
Descaling					
Turkish bath with temperature control					
Turkish bath					
Ceiling light					



optional
 standard
 not available

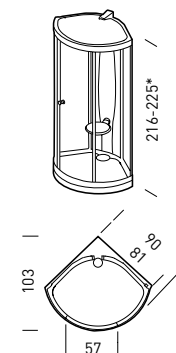

* = the shower tray can be 85 mm or 175 mm deep

157
GIOACCHINI DESIGN
112x66,5-80 cm



Shower enclosure colours (Acrylic)



White (A)
European White (Y)

Combinations (Acrylic)

[7] Pearl Ice/Grey (SKY)

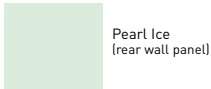

Pearl Ice (rear wall panel)

Grey (roof, shower tray, top rail)

[Q] Pearl Ice/A

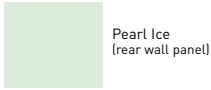

Pearl Ice (rear wall panel)

White (A) (roof, shower tray, top rail)

[K] Pearl Ice/Y

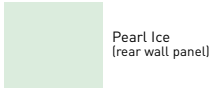

Pearl Ice (rear wall panel)

European White (Y) (roof, shower tray, top rail)

[Z] Pearl White/Y

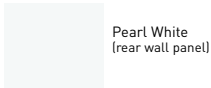

Pearl White (rear wall panel)

European White (Y) (roof, shower tray, top rail)



Version with transparent side panel



- DUAL FUNCTION CENTRAL SHOWER HEAD WITH LIGHT
- AIR RECIRCULATION
- HAND SHOWER ON RAIL
- TAPS
- CONTROL PANEL
- MULTI-FUNCTION JET
- FOLD-DOWN SEAT
- STEAM OUTLET AND AROMATHERAPY OIL DISPENSER

Functions

	157 Base	157 Multi-function LIGHT	157 Multi-function	157 COMFORT LIGHT	157 COMFORT	157 EXECUTIVE
Hand shower						
Central shower head						
Roof						
Thermostatic mixer or single lever mixer tap						
Clean glass						
Water massage selection		man.	man.	man.	man.	dig.
Vertical massage						
Water test nozzle						
Massaging strip						
Fold-down seat						
Removable methacrylate seat						
Control panel						
Aromatherapy oil dispenser						
Air recirculation						
Descaling						
Turkish bath with temperature control						
Turkish bath						
Ceiling light						
Scottish shower						
Radio (Acoustic Panel)						
Lymphatic drainage						



■ optional ■ standard □ not available

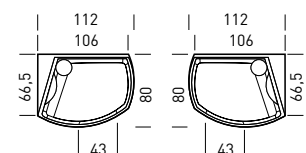
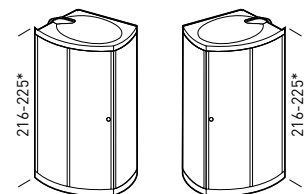

right version left version

* = the shower tray can be 85 mm or 175 mm deep

140 NEXT

TALOCCI DESIGN

140x92 cm



Shower enclosure colours
Acrylic



- HAND SHOWER ON RAIL
- MIRROR
- CONTROL PANEL
- TEMPERED GLASS SLIDING DOOR AND PANELS
- MULTI-FUNCTION JET
- INTEGRATED SEATS
- VAPORISER AND AROMATHERAPY OIL DISPENSER
- FOOT MASSAGE
- SHOWER TRAY WITH SLIP-RESISTANT BOTTOM

Functions	140 Base	140 Multi-function	140 EXECUTIVE	140 ELITE
Hand shower on rail				
Roof with central shower head				
Thermostatic mixer or single lever mixer tap				
Clean glass				
Silver version				
Water massage selection		man.	man.	dig.
Water massages				
Control panel				
Aromatherapy oil dispenser				
Air recirculation				
Descaling				
Turkish bath with temperature control				
Ceiling light				
Radio (Acoustic Panel)				
Lymphatic drainage				
Scottish shower				
Chromoexperience				
Thermostatic mixer and electronic flow diverter				

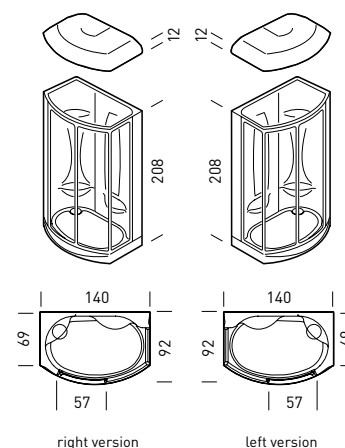

optional
 standard
 not available

146 NEXT

LENCI DESIGN

110x80 cm



Shower enclosure colours
Acrylic



Functions

	146 Base	146 Multi-function	146 COMFORT	146 EXECUTIVE	146 ELITE
Hand shower on rail					
Roof with central shower head					
Thermostatic mixer or single lever mixer tap					
Clean glass					
Silver version					
Water massage selection		man.	man.	man.	dig.
Water massages					
Control panel					
Aromatherapy oil dispenser					
Air recirculation					
Descaling					
Turkish bath with temperature control					
Ceiling light					
Radio (Acoustic Panel)					
Lymphatic drainage					
Scottish shower					
Chromoexperience					
Thermostatic mixer and electronic flow diverter					

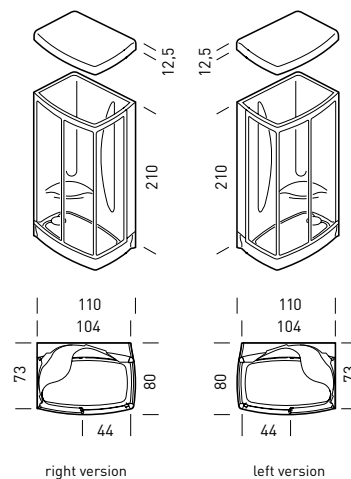

optional
 standard
 not available

148 NEXT
LENCI-TALOCCI DESIGN
115x85 cm



Shower enclosure colours
Acrylic



Functions

	148 Base	148 Multi-function	148 COMFORT	148 EXECUTIVE	148 ELITE
Hand shower on rail					
Roof with central shower head					
Thermostatic mixer or single lever mixer tap					
Clean glass					
Silver version					
Water massage selection		man.	man.	man.	dig.
Water massages					
Control panel					
Aromatherapy oil dispenser					
Air recirculation					
Descaling					
Turkish bath with temperature control					
Ceiling light					
Radio (Acoustic Panel)					
Lymphatic drainage					
Scottish shower					
Chromoexperience					
Thermostatic mixer and electronic flow diverter					

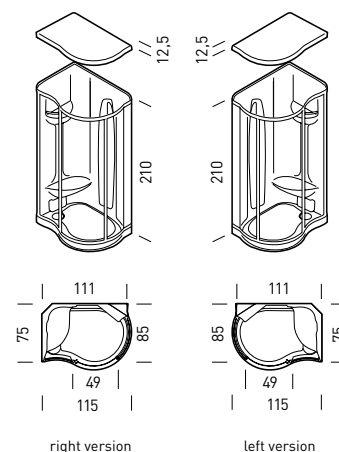

optional
 standard
 not available

154 NEXT

TALOCCI DESIGN

90x75 cm



Shower enclosure colours

Acrylic



White (A)

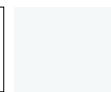

European White (Y)

Colour of footboard, seat, storage shelf



Cloud grey (&)



Grey



CENTRAL SHOWER HEAD

STORAGE SHELF

HAND SHOWER ON RAIL

THERMOSTATIC MIXER

CONTROL PANEL

MULTI-FUNCTION JET

FOLD-DOWN SEAT

STEAM OUTLET AND AROMATHERAPY OIL DISPENSER

FOOT MASSAGE

Functions

	154 Base	154 Multi-function	154 COMFORT
Hand shower on rail			
Roof			
Thermostatic mixer or single lever mixer tap			
Silver version			
Central shower head			
Clean glass			
Water massage selection		man.	man.
Water massages			
Control panel			
Aromatherapy oil dispenser			
Air recirculation			
Descaling			
Turkish bath with temperature control			
Ceiling light			



optional
 standard
 not available

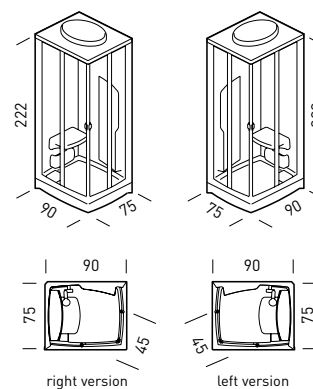

161 NEXT

LENCI DESIGN

90x90 cm



Shower enclosure colours
Acrylic



Functions

	161 Base	161 Multi-function	161 COMFORT
Hand shower on rail			
Roof with central shower head			
Thermostatic mixer or single lever mixer tap			
Clean glass			
Silver version			
Water massage selection		man.	man.
Water massages			
Control panel			
Aromatherapy oil dispenser			
Air recirculation			
Descaling			
Turkish bath with temperature control			
Ceiling light			



optional
 standard
 not available

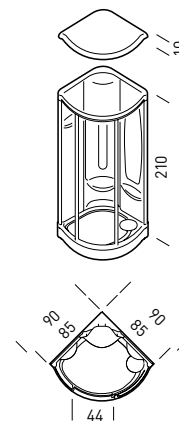

SHOWER ENCLOSURE SYSTEM

SHOWER TRAYS **PERSPECTIVE**



square
80x80 cm
90x90 cm
PAGE 94



rectangular
75x90 cm
75x100 cm
75x120 cm
75x140 cm
75x160 cm
90x140 cm
90x160 cm
PAGE 94



curved corner
90x90 cm
PAGE 94

SHOWER TRAYS **WILMOTTE**



NT51: 80x80 cm
NT53: 90x90 cm
PAGE 95



NT52: 90x70 cm
NT55: 100x80 cm
NT56: 120x80 cm
NT57: 140x80 cm
PAGE 95

SHOWER TRAYS **UNLIMITED**

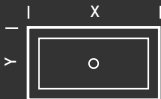

shower tray
PAGE 96

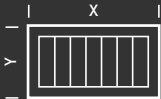

shower tray with slats
PAGE 96

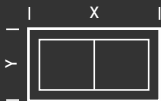
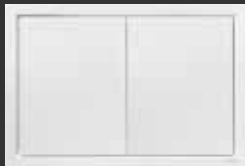

shower tray with footboard/s
PAGE 96

X - Y = The length and width of the shower tray varies by the centimetre from 80x90 to 200x120 cm.

SHOWER DOORS PERSPECTIVE



2 hinged doors

70 cm
75 cm
80 cm
90 cm
100 cm

PAGE 98



1 hinged door

75 cm
80 cm
90 cm
100 cm
120 cm
140 cm
160 cm

PAGE 98



fixed side panel

70 cm
75 cm
80 cm
90 cm
100 cm

PAGE 98



recessed

75 cm
80 cm
90 cm
100 cm
120 cm
140 cm
160 cm

PAGE 98



curved corner

90 cm

PAGE 98

SHOWER DOORS UNLIMITED

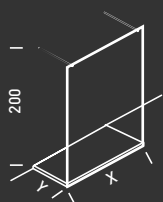

**fixed front glass panel
free-standing version**

PAGE 102

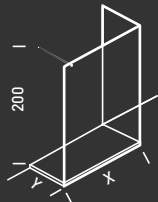

**fixed front and side glass panels with side opening
free-standing version**

PAGE 102

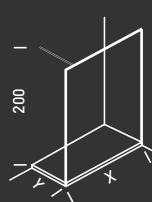

**fixed front glass panel
and side opening
corner version**

PAGE 102

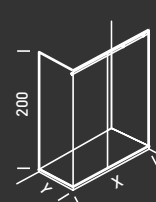

**corner opening
and fixed glass panel
corner version**

PAGE 102

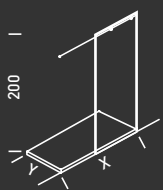

**fixed panel and opening
recessed version**

PAGE 102

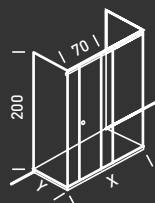

**sliding door
and fixed glass panels
centre-of-the-wall
version**

PAGE 102

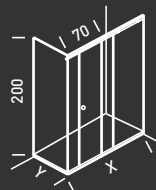

**sliding door and fixed
glass panels
corner version**

PAGE 102

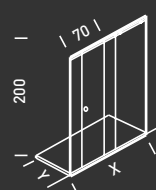

**sliding door
and fixed glass panel
recessed version**

PAGE 102

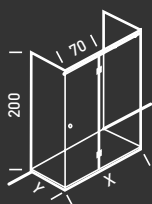

**sliding door
and fixed glass panels
centre-of-the-wall
version**

PAGE 102

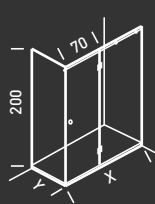

**hinged door and fixed
short side glass panel
corner version**

PAGE 102

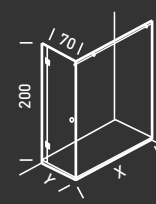

**hinged door and fixed
long side glass panel
corner version**

PAGE 102

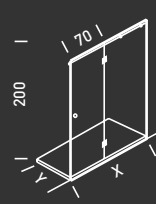

**hinged door
and fixed glass panel
recessed version**

PAGE 102

PERSPECTIVE and UNLIMITED doors can be combined with all three shower tray ranges PERSPECTIVE, WILMOTTE and UNLIMITED.

SHOWER TRAYS PERSPECTIVE



SQUARE



80 x 80
90 x 90

RECTANGULAR

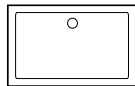

75 x 90
75 x 100
75 x 120
75 x 140
75 x 160
90 x 140
90 x 160

CURVED CORNER

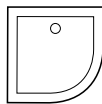

90 x 90

METHOD OF INSTALLATION

ABOVE-FLOOR installation

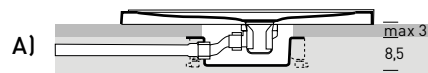

- Shower tray
- K053 Basin, drain trap, profiles for shower tray installation on finished floor (*)
- KP43 Basin and drain trap (*)
- KP70 High-flow drain trap (*)

FLOOR-FLUSH installation

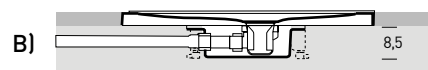

- Shower tray
- K053 Basin, drain trap, profiles for shower tray installation on finished floor (*)
- KP43 Basin and drain trap (*)
- KP70 High-flow drain trap (*)

(*) optional
measurements in centimetres

SHOWER TRAYS

BATHROOM SYSTEM WILMOTTE

SHOWER TRAYS

SHOWER ENCLOSURE SYSTEM



WILMOTTE shower trays are part of the bathroom system designed by J.M. Wilmotte. To see all the items in this collection, please refer to the dedicated catalogue.

SQUARE

RECTANGULAR

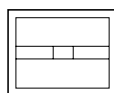

80 x 80
90 x 90

70 x 90
80 x 100
80 x 120
80 x 140

METHOD OF INSTALLATION

SIT-ON installation

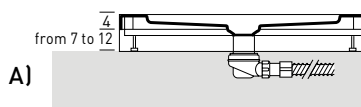

- Shower tray
- K102 Frame for floor-flush installation (*)
- K072 Drain trap (*)
- K071 High-flow drain kit (compulsory for high-flow tray)

ABOVE-FLOOR installation

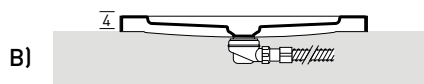

- Shower tray
- K072 Drain trap (*)
- K071 High-flow drain kit (compulsory for high-flow tray)

FLOOR-FLUSH installation

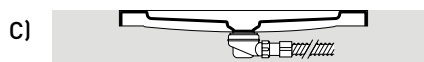

- Shower tray
- K072 Drain trap (*)
- K071 High-flow drain kit (compulsory for high-flow tray)

(*) optional measurements in centimetres

SHOWER TRAYS **UNLIMITED**



SHOWER TRAY

Material:
- Duralight™



SHOWER TRAY WITH SLATS

Material:
- Duralight™



SHOWER TRAY WITH FOOTBOARD/S

Material:
- Duralight™

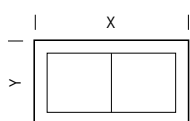
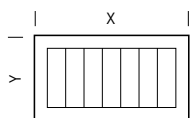
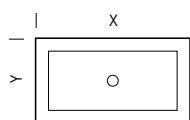

The following table simplifies your search for the ideal size of shower tray amongst those available. Depending on the size required (X, Y), use the table to determine the size of the internal basin, the number of footboards or the number of possible slats.

	80	90	100	110	120
90	A				
100					
110					
120					
130	B				
140					
150					
160	C				
170					
180					
190	D				
200					

A	B	C	D	
80x70	115x70	145x80	175x80	Size of internal basin (smooth shower tray)
1	2	2	3	Number of footboards (shower tray with footboards)
5	7	9	11	Number of slats (shower tray with slats)

METHOD OF INSTALLATION

ABOVE-FLOOR installation

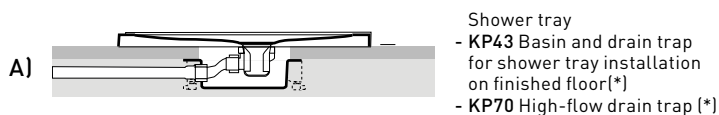

FLOOR-FLUSH installation

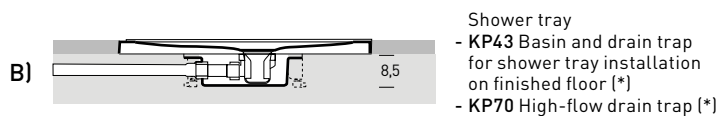

(*) optional measurements in centimetres

X - Y = The length and width of the shower tray and wall panels varies by the centimetre, to meet all dimensional requirements: from the 80x90 cm enclosure to the large 200x120 cm model (for detailed technical information please see the price list).

SHOWER DOORS **PERSPECTIVE**



HINGED DOOR CORNER VERSION

- 6 mm-thick glass
- Clean glass optional

Teamed with the following shower trays:

- UNLIMITED
- PERSPECTIVE
- WILMOTTE



HINGED DOOR RECESSED VERSION

- 6 mm-thick glass
- Clean glass optional

Teamed with the following shower trays:

- UNLIMITED
- PERSPECTIVE
- WILMOTTE



HINGED DOOR CURVED CORNER

- 6 mm-thick glass
- Clean glass optional

Teamed with the following shower trays:

- PERSPECTIVE

2 HINGED DOORS

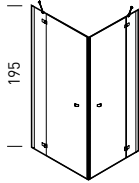

- 70 cm
- 75 cm
- 80 cm
- 90 cm
- 100 cm

FIXED SIDE PANEL

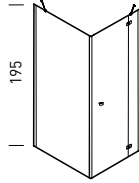

- 70 cm
- 75 cm
- 80 cm
- 90 cm
- 100 cm

1 HINGED DOOR
right or left hinge

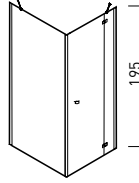

- 75 cm
- 80 cm
- 90 cm
- 100 cm
- 120 cm
- 140 cm
- 160 cm

RECESSED
right or left hinge

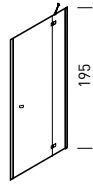

- 75 cm
- 80 cm
- 90 cm
- 100 cm
- 120 cm
- 140 cm
- 160 cm

TURNED CORNER
2 hinged doors

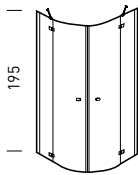

- 90 cm

SHOWER DOORS **PERSPECTIVE**



HINGED DOOR
(corner version)



HINGED DOOR
(recessed version)



HINGED DOOR
(curved corner version)

SHOWER DOORS UNLIMITED



FIXED GLASS PANEL

- 8 mm-thick glass
- Standard Clean glass

Teamed with the following shower trays:

- UNLIMITED
- PERSPECTIVE
- WILMOTTE



SLIDING DOOR

- 8 mm-thick glass
- Standard Clean glass

Teamed with the following shower trays:

- UNLIMITED
- PERSPECTIVE
- WILMOTTE



HINGED DOOR

- 8 mm-thick glass
- Standard Clean glass

Teamed with the following shower trays:

- UNLIMITED
- PERSPECTIVE
- WILMOTTE

FIXED FRONT GLASS PANEL
centre-of-the-wall version

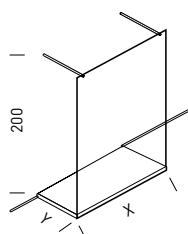

FIXED FRONT SIDE GLASS
PANELS WITH SIDE OPENING
free-standing version

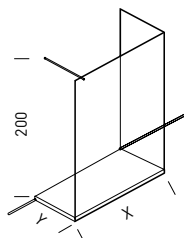

FIXED FRONT SIDE GLASS
PANELS WITH SIDE OPENING
corner version

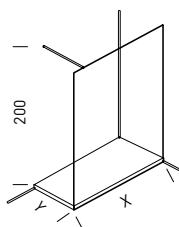

CORNER OPENING
AND FIXED GLASS PANEL
corner version

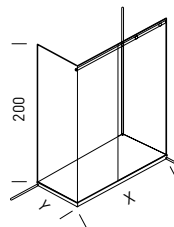

FIXED PANEL
AND OPENING
recessed version

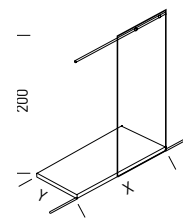

SLIDING DOOR AND FIXED
GLASS PANELS
centre-of-the-wall version

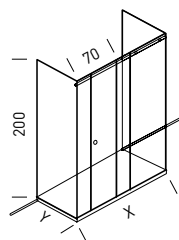

SLIDING DOOR AND FIXED
GLASS PANELS
corner version

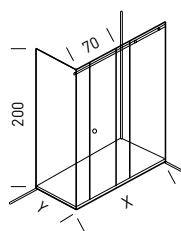

SLIDING DOOR AND FIXED
GLASS PANEL
recessed version

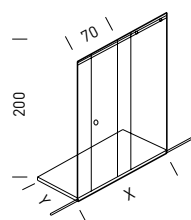

HINGED DOOR AND FIXED
GLASS PANELS
centre-of-the-wall version

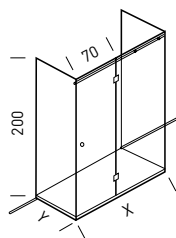

HINGED DOOR AND SHORT
FIXED SIDE GLASS PANEL
corner version

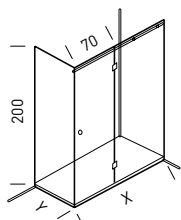

HINGED DOOR AND LONG
FIXED SIDE GLASS PANEL
corner version

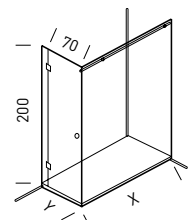

HINGED DOOR
AND FIXED GLASS PANEL
recessed version

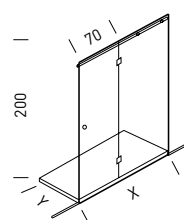

X - Y = The length and width of the shower tray and wall panels varies by the centimetre, to meet all dimensional requirements: from the 80x90 cm enclosure to the large 200x120 cm model (for detailed technical information please see the price list).

SHOWER DOORS **UNLIMITED**



SLIDING DOOR AND FIXED GLASS PANEL

(recessed version)

In the sliding door version,
the track ensures easy opening.

**FIXED FRONT GLASS PANEL**

(centre-of-the-wall version)

All the finishing touches in Unlimited shower enclosures are polished chrome or satin finish steel.

**HINGED DOOR AND SHORT FIXED SIDE GLASS PANEL**

(corner version)

Hinges, profiles and supports are down to the bare minimum to leave the transparency of glass intact.

COMBI UNITS



383
117x172,5 cm
PAGE 110



385
180x80-86 cm
PAGE 114



ARMONYA
H46M-546M: 170x70-80 cm
PAGE 118



SHARADE
HT1M-T01M: 170x70 cm
HT4M-T04M: 180x77 cm
PAGE 120



SINTESI 226-284
226: 170x70,5-85 cm
284: 160x70,5-85 cm
PAGE 122



SINTESI 286
180x80-97 cm
PAGE 124



250
170x80 cm
PAGE 126



252
140x140 cm
PAGE 128



257
125x125 cm
PAGE 130



258
125x125 cm
PAGE 130

TEUCO COMBI UNITS

383-385 details that make the difference.

The 383 and 385 combi units are more comfortable than conventional walk-in baths with showers. The full-height door grants access to a comfortable shower space which affords the utmost freedom of movement.

The comfortable and ergonomic bathtub can be fitted with Hydrosilence, Teuco's exclusive super-silent whirlpool. The 383 and 385 combi units thus offer genuine regenerating environments of relaxation to enjoy at any time without worrying about disturbing your neighbours.

At last an uncompromising product.

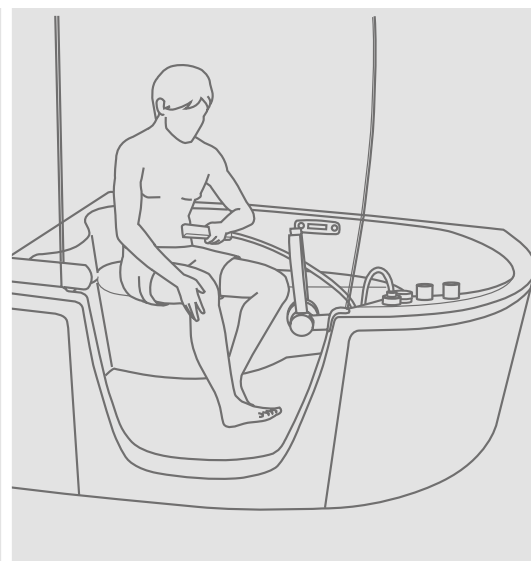
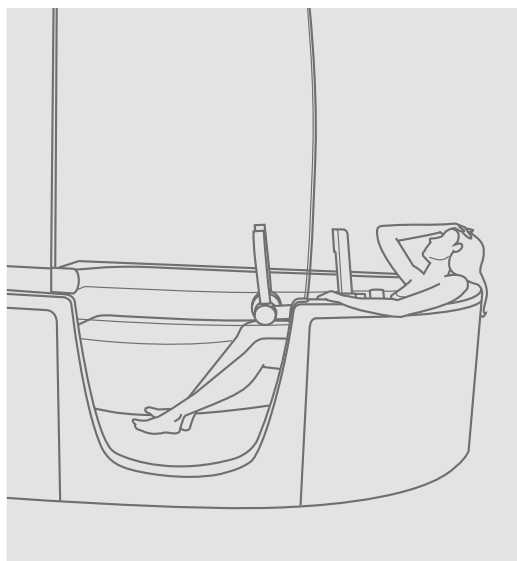

SEATS.

383 and 385 can also be used whilst seated, making them even more practical and safe. In the 383 model, the seat is built in, whereas in the 385 model it is removable. Safe use is further guaranteed by the wall-mounted hand-rail.



EASIER ACCESS THROUGH THE WIDE DOOR.

Getting into the 383 and 385 combi units is easy and safe, thanks to the full-height door which makes it easier to get into the bath without having to climb over the side.

The step is just 13 cm high.

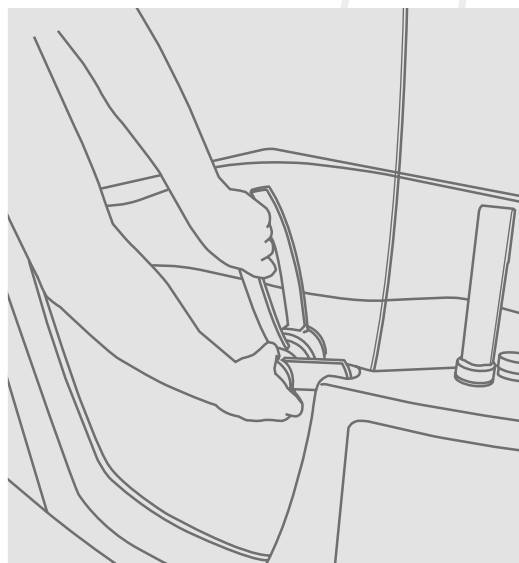

LONG-LEVER ACCESS HANDLE: MINIMUM EFFORT, MAXIMUM SAFETY.

To grant easy access to everyone, the door opens inwards with a long-lever handle that requires minimum effort.

Ensuring total safety: to prevent the door from being opened accidentally, the handle comes with a mechanical latch that can be opened from both the inside and the outside. Guaranteed against water leaks, thanks to the seal around the entire access perimeter.

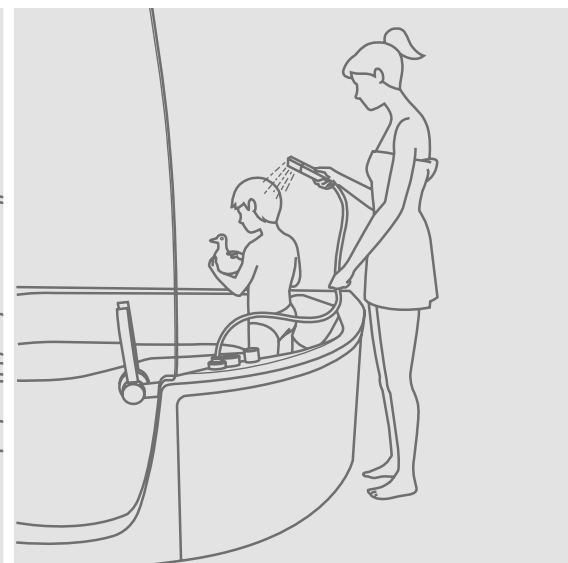

EASY TO USE.

Practical from any point of view as its ergonomic design makes it easy to use for the person inside and an assistant outside, where present.



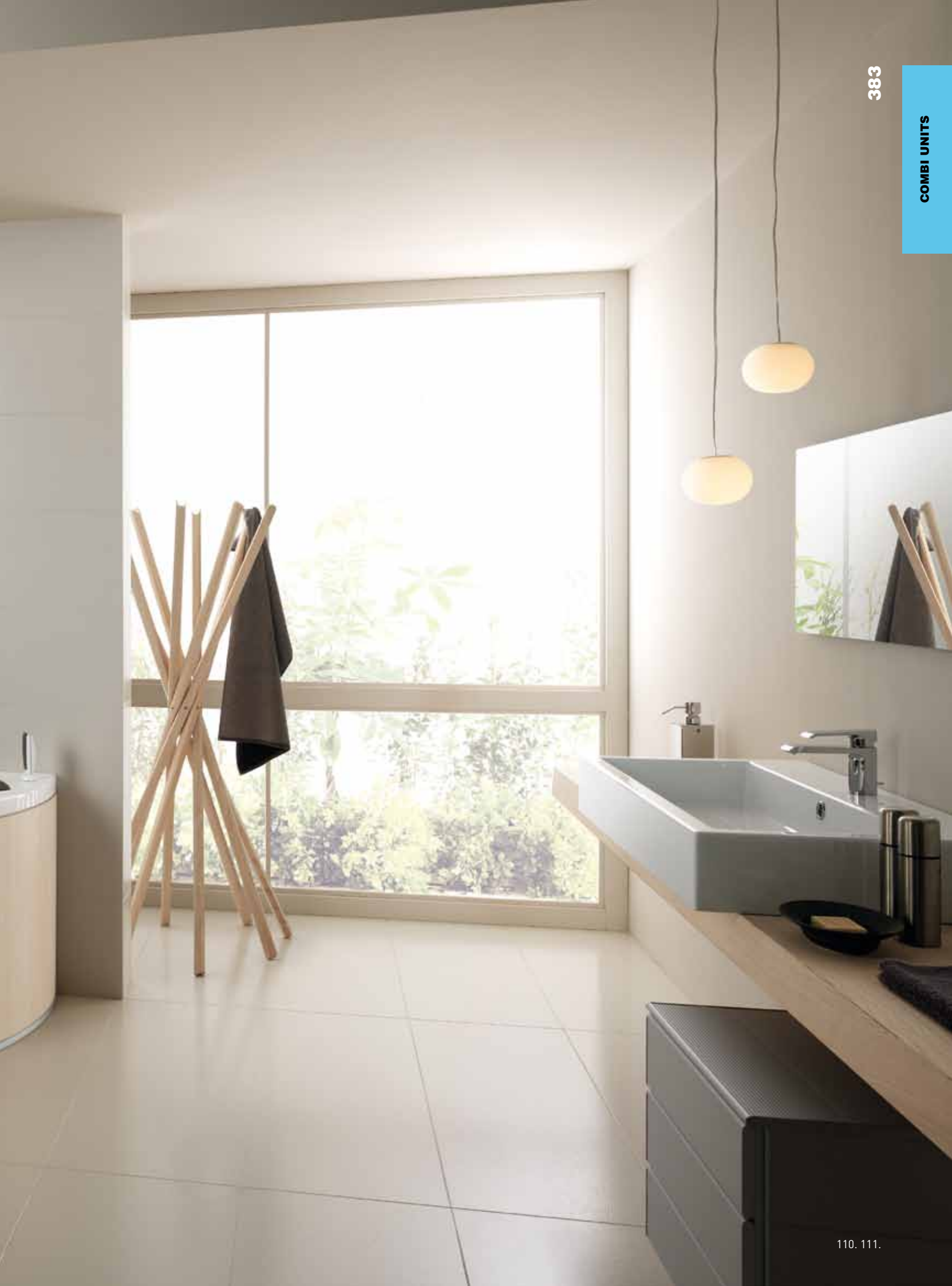

383
LENCI DESIGN
117x172,5 cm



**Wood finish panelling
(natural or synthetic)**



Limed oak-wood Anthracite oak-wood Wengé

Customisable covering



Acrylic panelling



White (A) European White (Y)

Bathtub colours



White (A) European White (Y)

Headrest



Grey



White acrylic

Limed oak-wood



Functions	Without whirlpool	J	BASIC G	E	TOP
Frame					
Integrated seat					
Headrest					
Drain column					
Whirlpool (no. of jets)		6	6	6	8
Control panel					
Massage intensity adjustment		man.	man.	man.	dig.
Level switch					
Backrest and headrest					
Hydro Clean System					
Hydrosilence					
Remote control					
Pulsator					
Chromoexperience					
Drain column with overflow and filler spout					
Wall-mounted hand rail					
Bathrobe holder					
Clean glass					

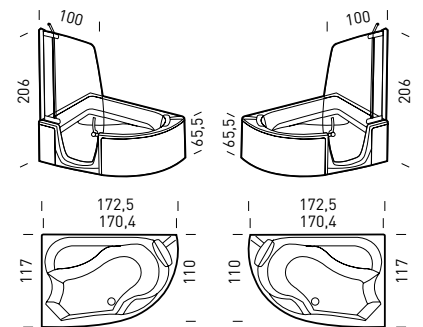

Water capacity 400 litres
(at overflow level)

■ optional ■ standard □ not available

normal

turned 180°







385
LENCI DESIGN
180x80-86 cm



**Wood finish panelling
(natural or synthetic)**



Limed oak-wood Anthracite oak-wood Wengé

Customisable covering



Acrylic panelling



White (A) European White (Y)

Bathtub colours



White (A) European White (Y)

Headrest



Grey



Functions

	Without whirlpool	J	BASIC G	E	TOP
Frame					
Removable seat					
Drain column					
Whirlpool (no. of jets)		6	6	6	8
Control panel					
Massage intensity adjustment		man.	man.	man.	dig.
Level switch					
Backrest and headrest					
Hydro Clean System					
Hydrosilence					
Remote control					
Pulsator					
Chromoexperience					
Drain column with overflow and filler spout					
Wall-mounted hand rail					
Clean glass					

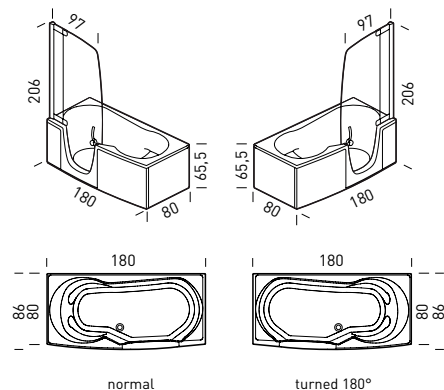

Water capacity 380 litres
(at overflow level)

■ optional ■ standard □ not available



ARMONYA

ANGELETTI RUZZA DESIGN

H46M-546M: 170x70-80 cm

H46 LIGHT-546 LIGHT: 170x70-80 cm



Bathtub colours



White (A) European White (Y)

Headrest



Grey

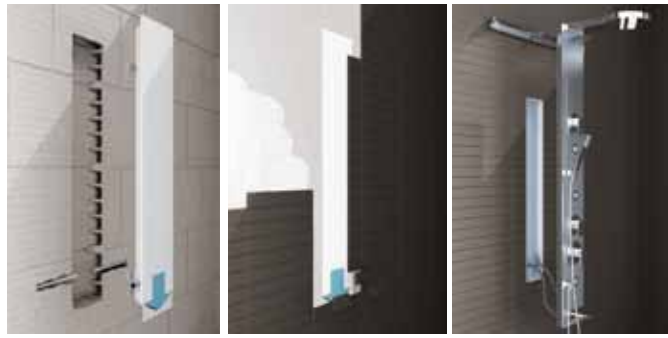

Recessing the multi-function shower panel preinstallation kit into the untilted wall



ARMONYA H46 LIGHT-546 LIGHT



ARMONYA H46M-546M



Bathtub functions

	Without whirlpool	J	BASIC G	E	TOP	HYDROSONIC GL	GXL
Frame							
Drain column							
Whirlpool (no. of jets)		6	6	6	8	8	8
Control panel							
Massage intensity adjustment		man.	man.	man.	dig.	dig.	dig.
Chromoexperience							
Headrest							
Level switch							
Backrest and headrest							
Hydro Clean System							
Hydrosilence							
Remote control							
Pulsator							
Hydrosonic							
Heater							
Radio (Acoustic Panel)							

Shower functions

	H46 - 546 LIGHT	H46M - 546M
Hand shower on rail		
Central shower head		
Thermostatic mixer or single lever mixer tap		
Water massage selection		man.
Water Massage		
Clean glass		

Water capacity 200 litres (at overflow level)

■ optional ■ standard □ not available

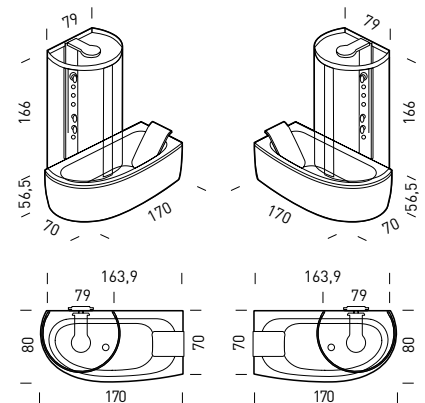

normal

turned 180°



SHARADE

TALOCCI DESIGN

HT1M-T01M: 170x70-84,5 cm

HT2M-T02M: 170x70-84,5 cm

HT4M-T04M: 180x77-93 cm

HT5M-T05M: 180x77-93 cm



Bathtub colours



Opal glass panels



Headrest and Seat



SHARADE version LIGHT without backlighting

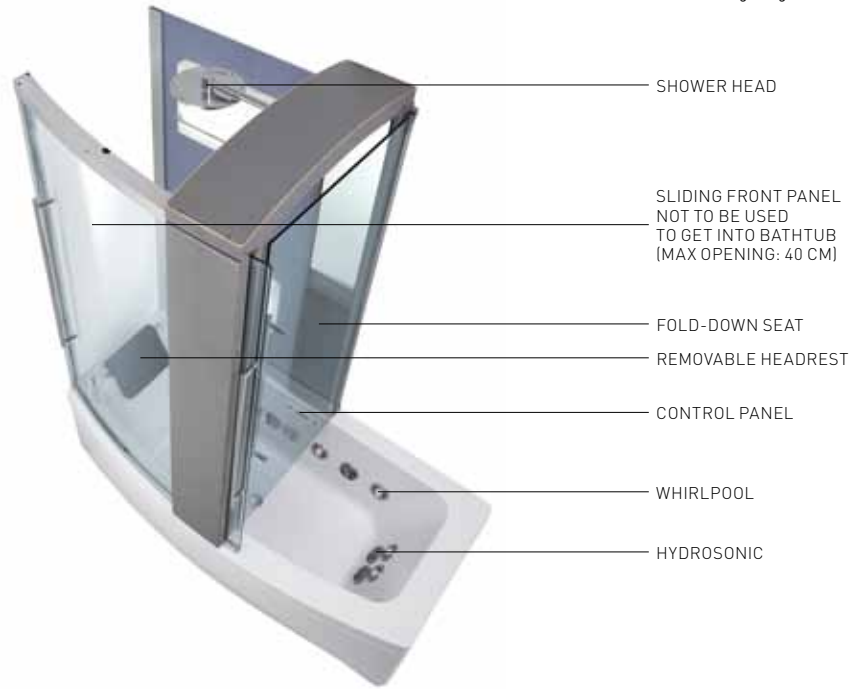

SHOWER HEAD

SLIDING FRONT PANEL
NOT TO BE USED
TO GET INTO BATHTUB
(MAX OPENING: 40 CM)

FOLD-DOWN SEAT

REMOVABLE HEADREST

CONTROL PANEL

WHIRLPOOL

HYDROSONIC



Functions

	Without whirlpool	J	BASIC G	E	TOP	HYDROSONIC GL	GXL
Frame							
Headrest							
Drain column							
Whirlpool (no. of jets)		6	6	6	8	8	8
Control panel							
Massage intensity adjustment		man.	man.	man.	dig.	dig.	dig.
Chromoexperience							
Level switch							
Backrest and headrest							
Hydro Clean System							
Hydrosilence							
Remote control							
Pulsator							
Hydrosonic							
Heater							
Radio (Acoustic Panel)							

Shower functions

	HT01-T01-HT05-T05 LIGHT with backlighting	HT02-T02-HT04-T04 no backlighting
Hand shower		
Central shower head		
Thermostatic mixer or single lever mixer tap		
Clean glass		
Water massage selection	man.	man.
Water Massage		
Seat		
Sliding front panel		
Backlit rear wall panel		

Water capacity:
HT01, T01, HT02, T02 = 200 litres
HT04, T04, HT05, T05 = 242 litres
(at overflow level)

■ optional ■ standard □ not available

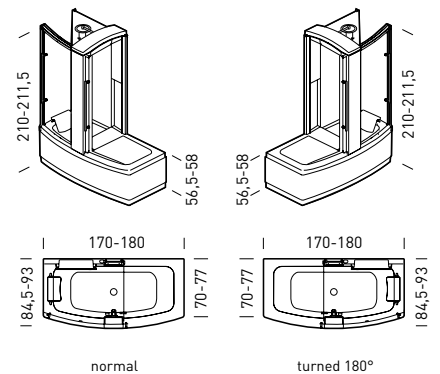

SINTESI 226-284

LENCI-TALOCCI DESIGN

226: 170x70,5-85 cm

284: 160x70,5-85 cm



Colours

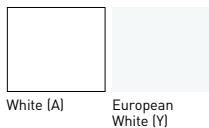

Polyurethane parts

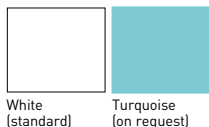

- SHOWER HEAD
- HAND SHOWER ON RAIL
- MIRROR
- STORAGE SHELVES
- TEMPERED GLASS SLIDING DOOR AND PANELS
- WATER MASSAGE JETS
- FOOT MASSAGE
- REMOTE CONTROL
- REMOVABLE POLYURETHANE SEAT
- CONTROL PANEL



Bathtub functions

	Without whirlpool	EASY	TOP
Frame			
Drain column			
Removable seat			
284 - Whirlpool (no. of jets)		6	6
226 - Whirlpool (no. of jets)		6	8
Control panel			
Massage intensity adjustment		man.	dig.
Level switch			
Backrest and headrest			
Hydro Clean System			
Hydrosilence			
Remote control			
Pulsator			

Shower functions

	284 - 226	284 - 226 Multi-function
Hand shower on rail		
Central shower head		
Roof		
Thermostatic mixer or single lever mixer tap		
Water massage selection		man.
Water Massage		
Equipped shower panel for version on free side		
Clean glass		

Water capacity:
284 = 180 litres - 226 = 190 litres
(at overflow level)

optional
 standard
 not available

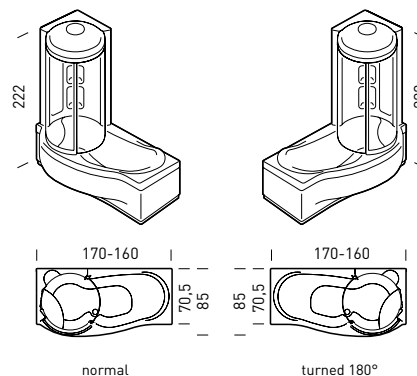

SINTESI 286

LENCI-TALOCCI DESIGN

180x80-97 cm



Colours



White (A)

European White (Y)



Bathtub functions

	Without whirlpool	EASY	TOP
Frame			
Drain column			
Whirlpool (no. of jets)		6	8
Control panel			
Massage intensity adjustment		man.	dig.
Level switch			
Backrest and headrest			
Hydro Clean System			
Hydrosilence			
Remote control			
Pulsator			

Shower functions

	286	286 Multi-function
Hand shower on rail		
Central shower head		
Roof		
Thermostatic mixer or single lever mixer tap		
Water massage selection		man.
Water Massage		
Equipped shower panel for version on free side		
Clean glass		

Water capacity 230 litres (at overflow level)

optional
 standard
 not available

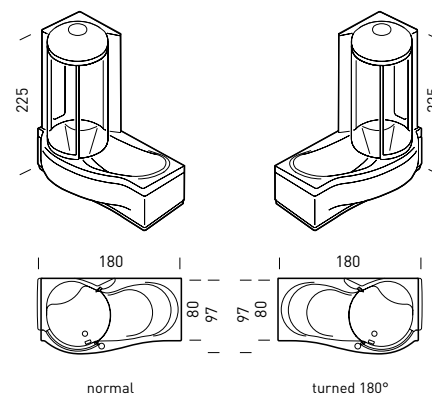

250
LENCI-TALOCCI DESIGN
170x80 cm



Bathtub colours

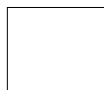

White (A)

Polyurethane parts



White (standard)



Turquoise (on request)



- HAND SHOWER ON RAIL
- REMOVABLE SEAT
- WATER MASSAGE JETS
- SLIDING DOOR
- THERMOSTATIC MIXER
- FOOT MASSAGE
- CONTROL PANEL
- POLYURETHANE FOLD-DOWN SEAT



Bathtub functions

	Without whirlpool	TOP
Frame		
Drain column		
Fold-down seat		
Whirlpool (no. of jets)		8
Control panel		
Massage intensity adjustment		dig.
Level switch		
Backrest and headrest		
Hydro Clean System		
Hydrosilence		
Pulsator		

Shower functions

	250S	250E
Hand shower on rail		
Roof with ceiling light		
Thermostatic mixer or single lever mixer tap		
Water massage selection	man.	dig.
Water Massage		
Control panel		
Aromatherapy oil dispenser		
Air recirculation		
Descaling		
Turkish bath with temperature control		
Radio (Acoustic Panel)		
Air system		
Clean glass		
Electronic riser rail		
Scottish shower		
Lymphatic drainage		
External control panel		

Water capacity 190 litres (at overflow level)

optional
 standard
 not available

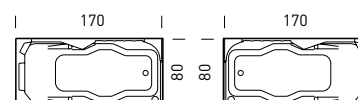
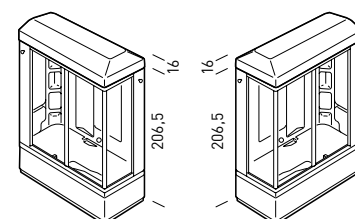

right version

left version



252
LENCI-TALOCCI DESIGN
140x140 cm



Bathtub colours



White (A)

Polyurethane parts



White (standard)



Turquoise (on request)



HAND SHOWER ON RAIL

MIRROR
WATER
MASSAGE JETS

SLIDING DOOR

FOOT MASSAGE

CONTROL PANEL
REMOTE CONTROL



Bathtub functions

	Without whirlpool	TOP
Frame		
Drain column		
Removable seat		
Whirlpool (no. of jets)		8
Control panel		dig.
Massage intensity adjustment		
Level switch		
Backrest and headrest		
Hydro Clean System		
Hydrosilence		
Pulsator		

Shower functions

	252M	252S	252E
Hand shower on rail			
Water massage selection	man.	man.	dig.
Water Massage			
Roof with ceiling light			
Central shower head			
Thermostatic mixer or single lever mixer tap			
Electronically controlled thermostatic mixer			
Control panel			
Aromatherapy oil dispenser			
Air recirculation			
Descaling			
Turkish bath with temperature control			
Radio (Acoustic Panel)			
Air system			
Electronic riser rail			
Scottish shower			
Lymphatic drainage			
External control panel			
Clean glass			

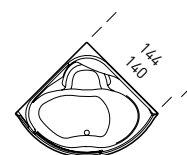
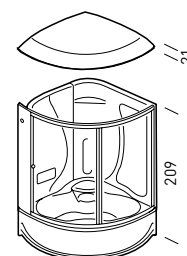

Water capacity 242 litres (at overflow level)

optional
 standard
 not available



257-258

LENCI-TALOCCI DESIGN

257: 125x125 cm

258: 125x125 cm



Bathtub colours



White (A)



257M



258

- HAND SHOWER ON RAIL
- MIRROR
- SLIDING DOOR
- WATER MASSAGE JETS
- THERMOSTATIC MIXER
- FOOT MASSAGE
- REMOTE CONTROL
- WATER OUTLET SPOUT
- CONTROL PANEL



Bathtub functions

	Without whirlpool	EASY	TOP
Frame			
Drain column			
Whirlpool (no. of jets)		6	6
Control panel			
Massage intensity adjustment		man.	dig.
Level switch			
Backrest and headrest			
Hydro Clean System			
Hydrosilence			
Remote control			
Pulsator			

Shower functions

	257	257M	258R
Hand shower on rail			
Thermostatic mixer or single lever mixer tap			
Central shower head			
Water massage selection		man.	dig.
Water Massage			
Integrated seat			
Roof			
Aromatherapy oil dispenser			
Air recirculation			
Descaling			
Turkish bath with temperature control			
Ceiling light			
Clean glass			

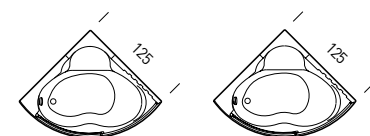
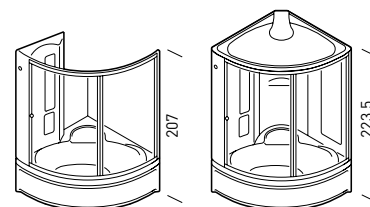

257

258

Water capacity 170 litres (at overflow level)

optional
 standard
 not available



EQUIPPED SHOWER PANELS



P546-P547
160x20,5 cm
PAGE 134



P10-P11
150x32 cm
PAGE 136



P12-P13
P12: 204x34,7 cm
P13: 172x34,7 cm
PAGE 138

P546-P547
ANGELETTI-RUZZA DESIGN
160x20,5 cm



Colours



Aluminium [9]

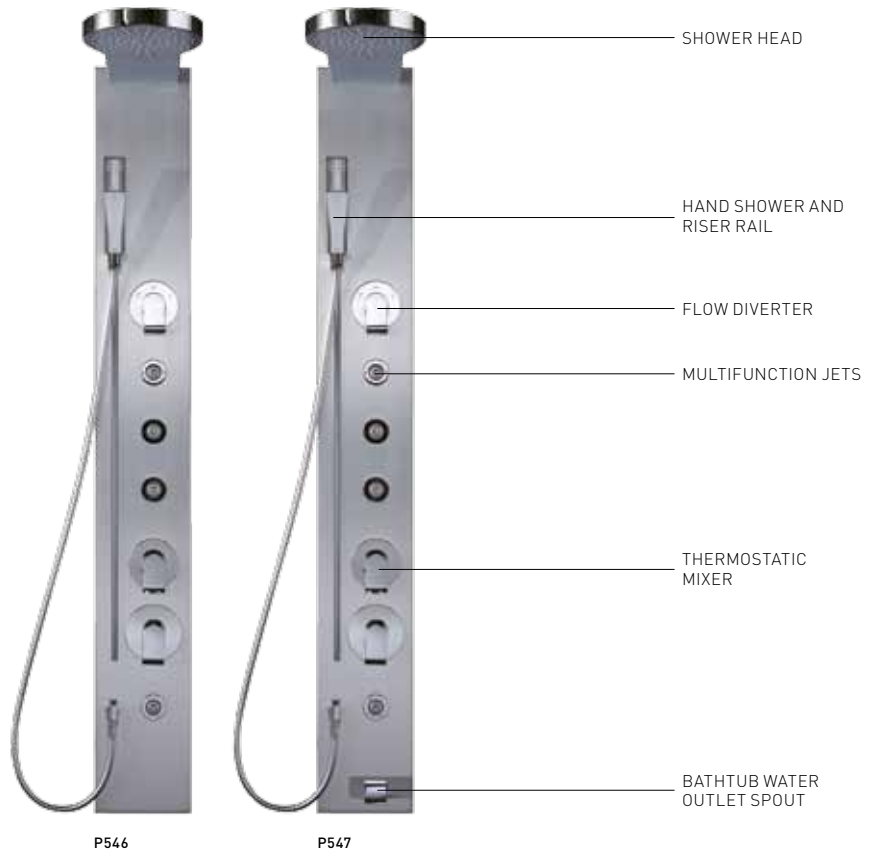

Functions

	P546	P547
Equipped panel for shower		
Equipped panel for bathtub		
Thermostatic mixer or single lever mixer tap		
Water massage selection	man.	man.
Vertical massage (no. of jets)	4	4
Shower head		
Hand shower and riser rail		
Bathtub water outlet spout		



standard not available

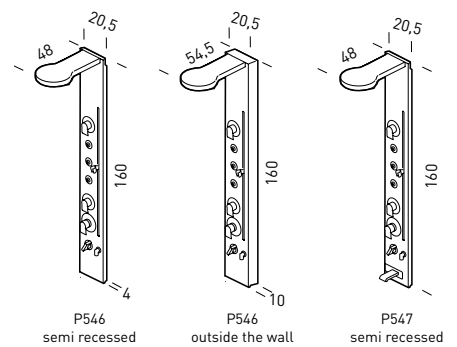

P10-P11
PAOLO D'ARRIGO DESIGN
150x32 cm



Colours Duralight™



Moonstone (2) Celestine (3)

Glass



Aquamarine (8)

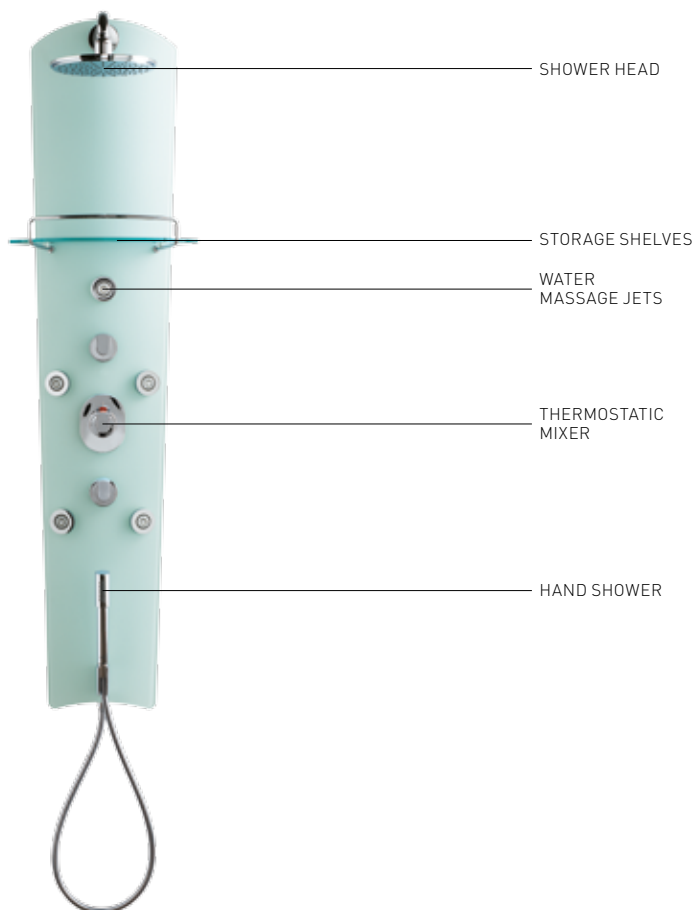

Functions

	P10	P11
Equipped side shower panel		
Equipped corner shower panel		
Thermostatic mixer		
Water massage selection	man.	man.
Vertical massage (no. of jets)	5	5
Adjustable central shower head		
Hand shower		



standard not available

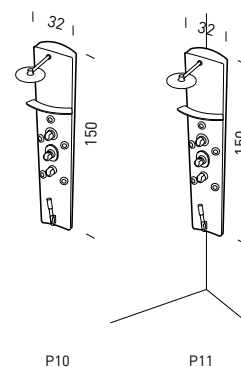

P10

P11

P12-P13

TALOCCI DESIGN

P12: 204x34,7 cm

P13: 172x34,7 cm



Colours



Aluminium [9]

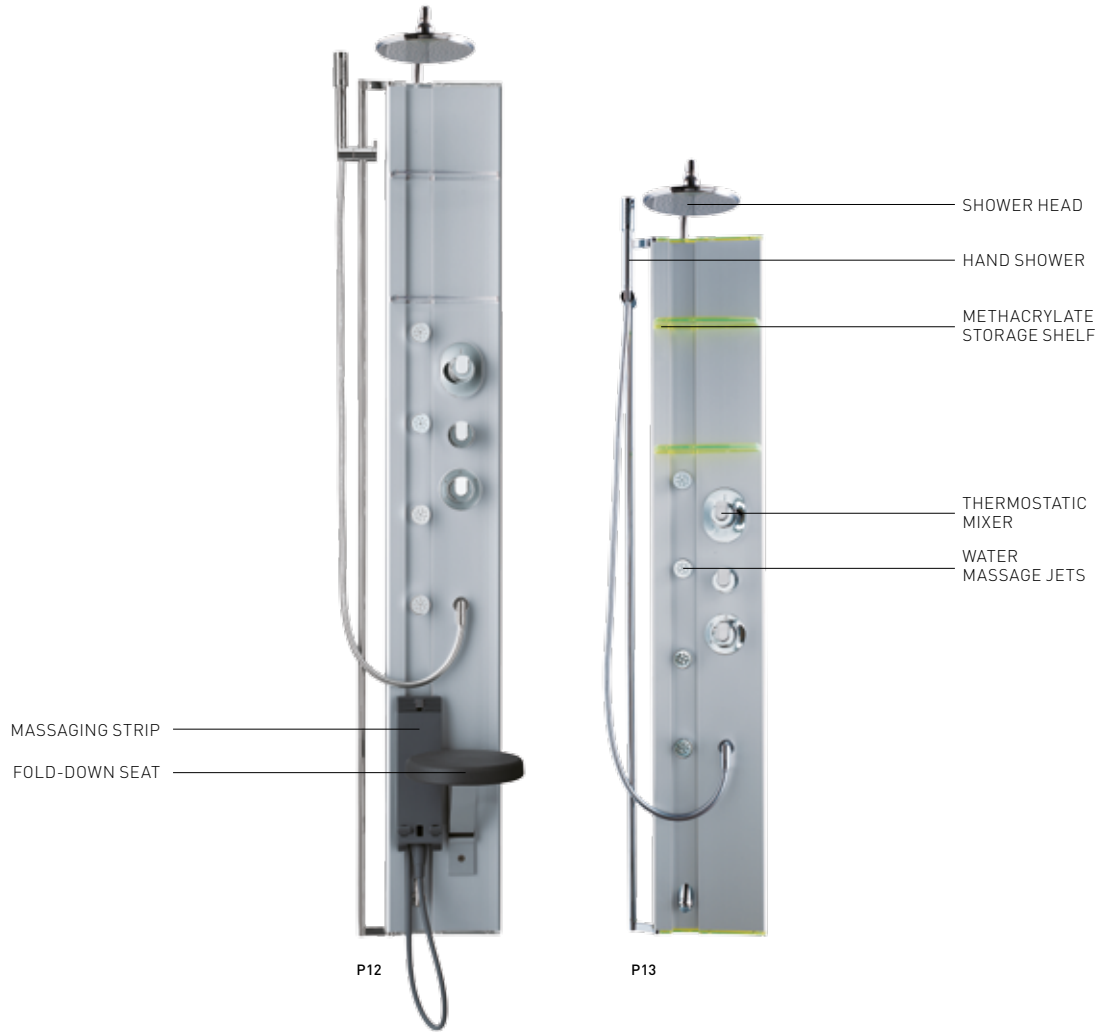

Functions

	P12	P13
Shower on the rail		
Thermostatic mixer or single lever mixer tap		
Water massage selection	man.	man.
Vertical massage [no. of jets]	4	4
Adjustable central shower head		
Massaging strip		
Fold-down seat		
Water test nozzle		



■ standard □ not available

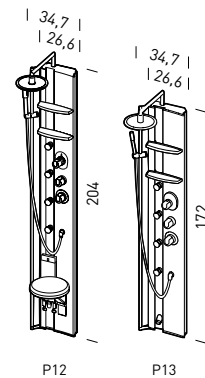



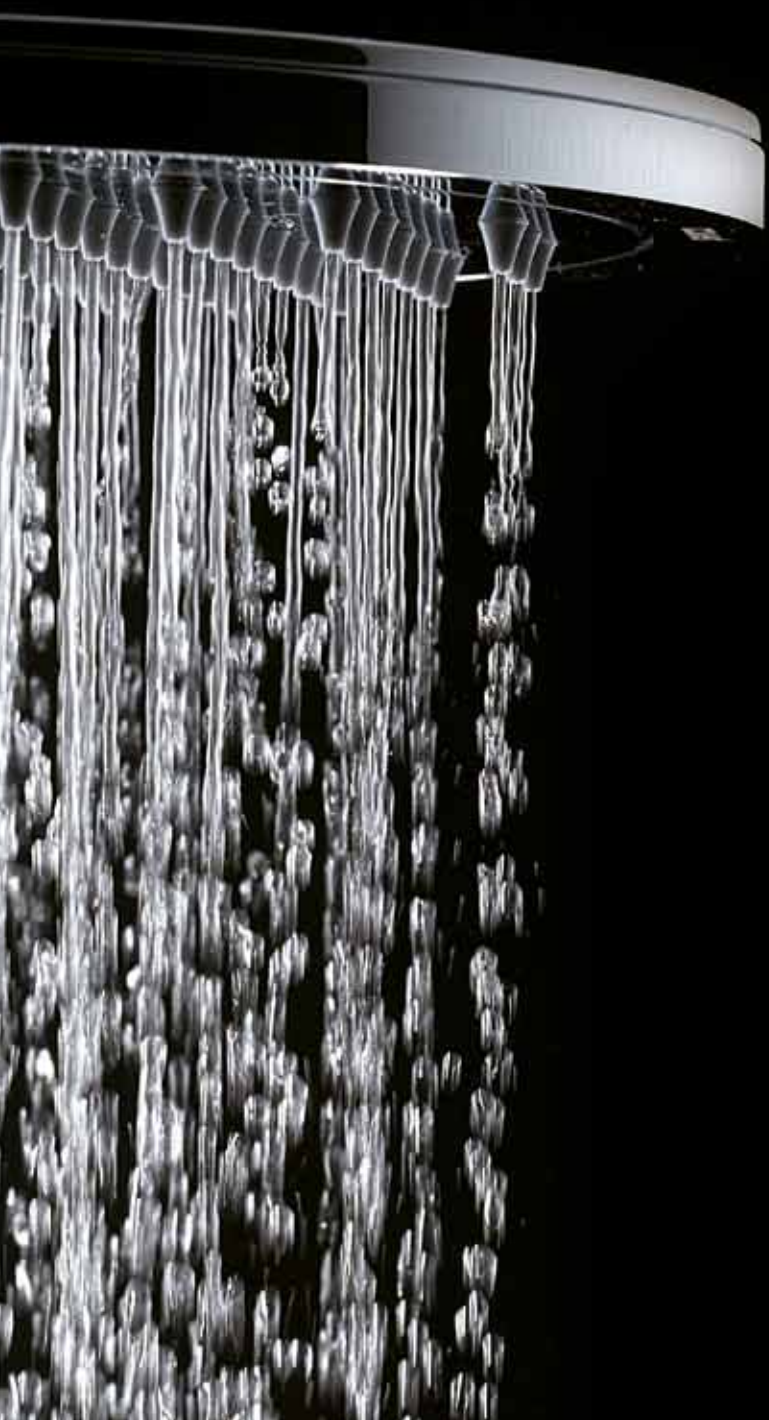

WATER FEATURES

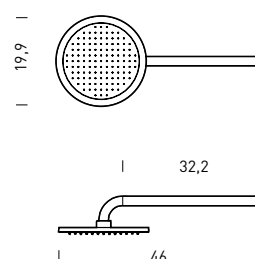
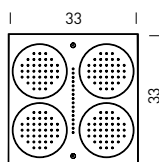
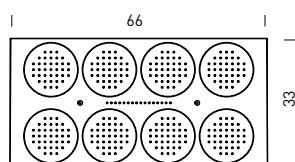
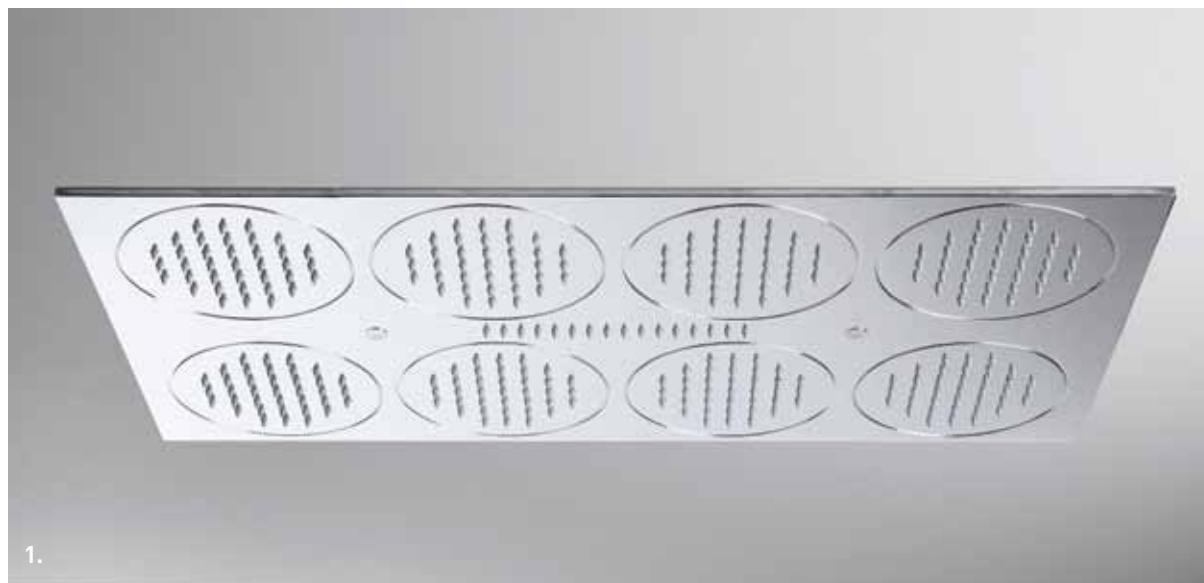

1. RA32----

RECTANGULAR CENTRAL SHOWER HEAD

330x660 mm inset into the false ceiling or ceiling-mounted, dual rain spray and concentrated massage function, 296+16 anti-lime scale nozzles, chromed brass body, double 1/2" fitting. Efficient massage even with a 10 l/minute flow rate.

2. RA33----

SQUARE CENTRAL SHOWER HEAD

330x330 mm inset into the false ceiling or ceiling-mounted, dual rain spray and concentrated massage function, 148+16 anti-lime scale nozzles, chromed brass body, double 1/2" fitting. Efficient massage even with a 10 l/minute flow rate.

3. RA31----

WALL-MOUNTED CENTRAL SHOWER HEAD

for wall fastening, 200 mm in diameter, 350 mm rod, 121 anti-lime scale nozzles, chromed brass body, washer, 1/2" wall fitting.

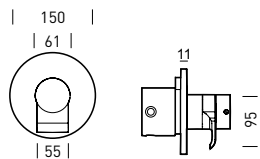

4. RA10----
**THERMOSTATIC MIXER
 WITH BUILT-IN STOP COCK**
 thermostatic mixer with inset
 built-in flow regulator,
 150mm diameter cover plate,
 3/4" fittings. High flow rate
 even with low water pressures.

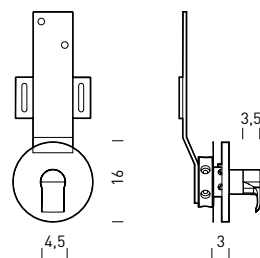

**5. RA12----, RA13----,
 RA14----, RA15----**
FLOW DIVERTER
 inset 2-5 way, 160 mm
 diameter cover plate,
 1/2" fittings.

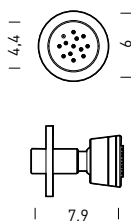

6. RA21----
WALL JET
 massage jet for wall
 mounting with anti-lime
 scale system, joint,
 washer, 1/2" fitting.
 Efficient massage even
 with a 2 l/minute flow rate.

WATER FEATURES



7.



8.

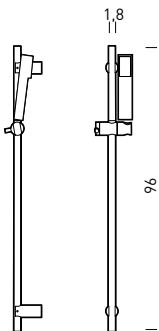

7. RA22----

LIGHT SHOWER RAIL

shower unit with riser rail, sliding rail support, shower with anti-lime scale system, 900 mm in length, 1500 mm long hose, washer, 1/2" wall fitting.

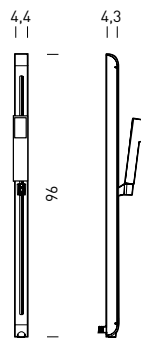

8. RA23----

SHOWER RAIL ON TRACK

shower unit with riser track, anti-lime scale shower system, 960 mm in length, 1500 mm long flexible hose, chromed brass and steel finishes, built-in 1/2" wall fitting.



9.



10.



11.

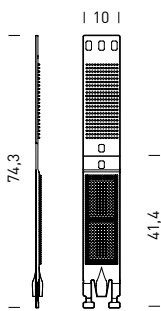

9. RA24----
MASSAGING STRIP
for wall mounting,
washer, 1/2" fitting.

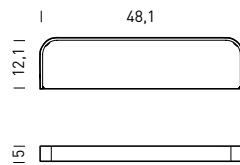

10. K040----
ACCESSORY SHELF
480 mm width, 120 mm
width, chromed brass
and steel finishes.

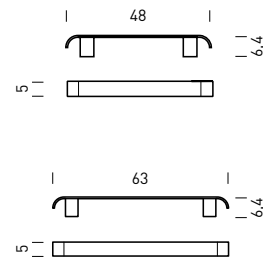

11. K041----, K042----
TOWEL RAIL,
630 or 480 mm length,
chromed brass body.

LEAF
ANGELETTI RUZZA DESIGN



RL26

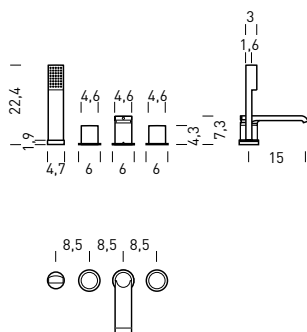

RL25
TUB LEDGE ASSEMBLY 4 HOLES
WITH HAND SHOWER:

- 175 MM DEEP
- SPOUT HEIGHT: 73 MM
- SIDE TAPS WITH 3/4" CERAMIC DISK TAPS
- AUTOMATIC BATH/SHOWER FLOW DIVERTER
- "NO DROP SYSTEM" HAND SHOWER
- SHOWER OUTLET WITH NON-RETURN VALVE

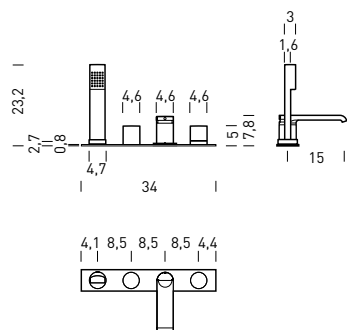

RL26
TUB LEDGE ASSEMBLY 4 HOLES WITH
HAND SHOWER AND FINISHING PLATE:

- 175 MM DEEP
- SPOUT HEIGHT: 73 MM
- SIDE TAPS WITH 3/4" CERAMIC DISK TAPS
- AUTOMATIC BATH/SHOWER FLOW DIVERTER
- "NO DROP SYSTEM" HAND SHOWER
- SHOWER OUTLET WITH NON-RETURN VALVE
- FINISHING PLATE

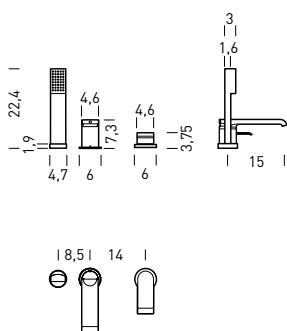

RL27
TUB LEDGE ASSEMBLY SINGLE LEVER
MIXER TAP WITH HAND SHOWER:

- 175 MM DEEP
- SPOUT HEIGHT: 73 MM
- SINGLE LEVER MIXER TAP CARTRIDGE Ø 38 MM
- AUTOMATIC BATH/SHOWER FLOW DIVERTER
- "NO DROP SYSTEM" HAND SHOWER
- SHOWER OUTLET WITH NON-RETURN VALVE

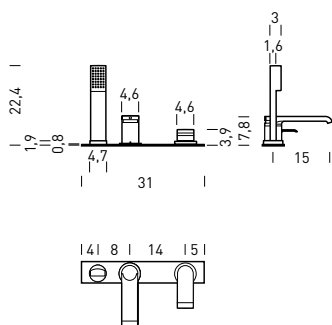

RL28
TUB LEDGE ASSEMBLY SINGLE LEVER MIXER TAP
WITH HAND SHOWER AND FINISHING PLATE:

- 175 MM DEEP
- SPOUT HEIGHT: 73 MM
- SINGLE LEVER MIXER TAP CARTRIDGE Ø 38 MM
- AUTOMATIC BATH/SHOWER FLOW DIVERTER
- "NO DROP SYSTEM" HAND SHOWER
- SHOWER OUTLET WITH NON-RETURN VALVE
- FINISHING PLATE

LEAF



RL21



RL22



RL23

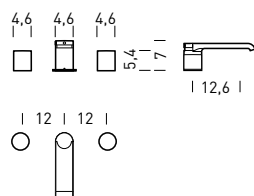

RL24

**RL21****THREE HOLE WASH BASIN TAP SET:**

- 150 MM DEEP
- SPOUT HEIGHT: 70 MM
- SIDE TAPS WITH 3/4" CERAMIC DISK TAPS
- 1 1/4" DRAIN TRAP
- 2 M 10X1 PRESSURE HOSES

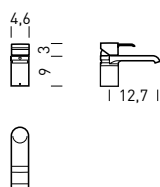
**RL22****SINGLE HOLE WASH BASIN TAP SET:**

- 150 MM DEEP
- SPOUT HEIGHT: 70 MM
- 1 1/4" DRAIN TRAP
- SINGLE LEVER MIXER TAP CARTRIDGE Ø32 WITH CERAMIC DISKS
- 2 M 10X1 PRESSURE HOSES, SCREW FITTING

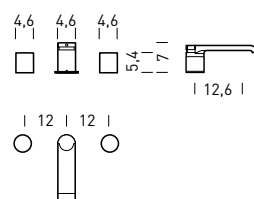
**RL23****THREE HOLE BIDET TAP SET:**

- 150 MM DEEP
- SPOUT HEIGHT: 70 MM
- SIDE TAPS WITH 1/2" CERAMIC DISK TAPS
- 1 1/4" DRAIN TRAP
- M 22X1 AERATOR WITH M 24X1 SWIVEL OUTLET
- 2 M 10X1 PRESSURE HOSES, SCREW FITTING

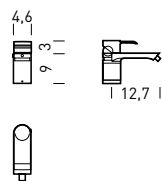
**RL24****SINGLE HOLE BIDET TAP SET:**

- 150 MM DEEP
- SPOUT HEIGHT: 70 MM
- 1 1/4" DRAIN TRAP
- SINGLE LEVER MIXER TAP CARTRIDGE Ø32 WITH CERAMIC DISKS
- M 22X1 AERATOR WITH M 24X1 SWIVEL OUTLET
- 2 M 10X1 PRESSURE HOSES, SCREW FITTING



R370



R380
HIGH CAPACITY WATERFALL
WALL-MOUNTED TUB ASSEMBLY:

- WITH SINGLE LEVER MIXER TAP AND AUTOMATIC FLOW DIVERTER
- SPOUT INCORPORATING LIQUID CRYSTAL THERMOMETER AND DIFFUSER
- 1800 MM LONG FLEXIBLE HOSE
- DUAL FUNCTION SHOWER:
 - SPRINKLER
 - MASSAGE JET
- WALL-MOUNTED SHOWER HOLDER



R370
HIGH CAPACITY WATERFALL TUB ASSEMBLY:

- WITH SINGLE LEVER MIXER TAP AND AUTOMATIC FLOW DIVERTER
- SPOUT INCORPORATING LIQUID CRYSTAL THERMOMETER AND DIFFUSER
- LEDGE-MOUNTED SHOWER HOLDER
- 1800 MM LONG FLEXIBLE HOSE
- DUAL FUNCTION SHOWER:
 - SPRINKLER
 - MASSAGE JET
- WALL-MOUNTED SHOWER HOLDER

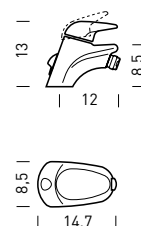
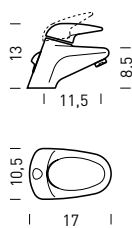
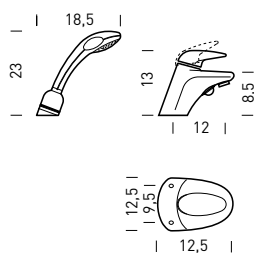

R371

TUB LEDGE ASSEMBLY:

- WITH SINGLE LEVER MIXER TAP AND AUTOMATIC FLOW DIVERTER
- SPOUT INCORPORATING LIQUID CRYSTAL THERMOMETER AND DIFFUSER
- LEDGE-MOUNTED SHOWER HOLDER
- 1800 MM LONG FLEXIBLE HOSE
- DUAL FUNCTION SHOWER:
 - SPRINKLER
 - MASSAGE JET
- WALL-MOUNTED SHOWER HOLDER

R570

WASH BASIN ASSEMBLY:

- WITH SINGLE LEVER MIXER TAP AND AUTOMATIC FLOW DIVERTER
- SPOUT INCORPORATING LIQUID CRYSTAL THERMOMETER AND AERATOR
- 1 1/4" DRAIN TRAP

R670

BIDET ASSEMBLY:

- WITH SINGLE LEVER MIXER TAP
- SPOUT INCORPORATING LIQUID CRYSTAL THERMOMETER
- SWIVEL OUTLET WITH AERATOR
- 1 1/4" DRAIN TRAP

COLOURS AND MATERIALS

Acrylic



White (A)

European White (Y)

Combinations for showers 155-156-157

(7) Pearl Ice/Grey (SKY)



Pearl Ice (rear wall panel)

Grey (roof, shower tray, top rail)

(Q) Pearl Ice/A



Pearl Ice (rear wall panel)

White (A) (roof, shower tray, top rail)

(K) Pearl Ice/Y

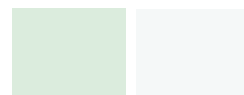

Pearl Ice (rear wall panel)

European White (Y) (roof, shower tray, top rail)

(Z) Pearl White/Y



Pearl White (rear wall panel)

European White (Y) (roof, shower tray, top rail)

Special colours for bathtubs



Pearl grey (U)

Edelweiss (D)

Jasmin (E)

Laser (F)

Pergamon (R)

Duralight™



White (A)

European White (Y)

Whisper Grey (M)

Pergamon (R)

Moonstone (2)

Celestine (3)

Cloud grey (&)

Natural stone



Slate grey (M1)

Pierre gris (M2)

Cognac (M3)

Absolut black (M4)

Polyurethane parts



White

Turquoise

Grey

Taps



White (A)

Chrome (N)

Aluminium



Aluminium (9)

Bathtub coverings



Acrylic



Wood finish (natural or synthetic)



Wood finish (natural or synthetic) and glass or Duralight™ top



Limed oak-wood

Anthracite oak-wood

Wengè



Customisable covering

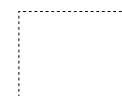

The photographic reproduction of the colour shades may not match the actual hue perfectly.

The information and characteristics specified in this catalogue do not bind Teuco Guzzini S.p.A., which reserves the right to make any changes without prior notice or replacement.